

# 8. APPLICATION DATA

## (1) Installation of indoor unit

RLF012A202B

Model SRK20,25,35,50,60ZSX  
R32/R410A REFRIGERANT USED

- This installation manual deals with an indoor unit installation only. For an outdoor unit installation, refer to page 56.
- This unit is designed for R32 or R410A. See a label on the outdoor unit to check refrigerant information.

### SAFETY PRECAUTIONS

- Before installation, read the "SAFETY PRECAUTIONS" carefully and strictly follow it during the installation work in order to protect yourself.
  - The precautionary items mentioned below are distinguished into two levels: **WARNING** and **CAUTION**.
  - **WARNING** Indicates a potentially hazardous situation which, if not avoided, can result in serious consequences such as death or severe injury.
  - **CAUTION** Indicates a potentially hazardous situation which, if not avoided, can result in personal injury or property damage.
- Both mention the important items to protect your health and safety. Therefore, strictly follow them by any means.









#### WARNING

- **Be sure to use only for residential purpose.**  
If this unit is installed in inferior environment such as machine shop, vehicle (like ship), warehouse, etc., it can malfunction.
- **Installation must be carried out by the qualified installer completely in accordance with the installation manual.**  
Installation by non qualified person or incorrect installation can cause serious troubles such as water leak, electric shock, fire and personal injury.
- **Be sure to wear protective goggles and gloves while performing installation work.**  
Improper safety measures can result in personal injury.
- **Use the original accessories and the specified components for the installation.**  
Using parts other than those prescribed may cause water leak, electric shock, fire and personal injury.
- **Do not install the unit near the location where leakage of flammable gases can occur.**  
If leaked gases accumulate around the unit, it can cause fire resulting in property damage and personal injury.
- **When installing the unit in small rooms, make sure that refrigerant density does not exceed the limit (Reference: ISO5149) in the event of leakage.**  
If refrigerant density exceeds the limit, consult the dealer and install the ventilation system. Otherwise lack of oxygen can occur resulting in serious accident.
- **Install the unit in a location where unit will remain stable, horizontal and free of any vibration transmission.**  
Unsuitable installation location can cause the unit to fall resulting in material damage and personal injury.
- **Do not run the unit with removed panels or protections.**  
Touching rotating equipments, hot surfaces or high voltage parts can cause personal injury due to entrapment, burn or electric shock.
- **This unit is designed specifically for R32 or R410A.**  
Using any other refrigerant can cause unit failure and personal injury.
- **Do not vent R32 or R410A into atmosphere.**  
R32 is a fluorinated greenhouse gas with a Global Warming Potential(GWP)=675.  
R410A is a fluorinated greenhouse gas with a Global Warming Potential(GWP)=2088.
- **Make sure that no air enters the refrigerant circuit when the unit is installed and removed.**  
If air enters the refrigerant circuit, the pressure in the refrigerant circuit will become too high, which can cause burst and personal injury.
- **Be sure to use the prescribed pipes, flare nuts and tools for R32 or R410A.**  
Using existing parts (for R22 or R407C) can cause refrigerant circuit burst resulting in unit failure and personal injury.
- **Be sure to connect both liquid and gas connecting pipes properly before operating the compressor.**  
**Do not open the liquid and gas service valves before completing piping work and evacuation.**  
If the compressor is operated when connecting pipes are not connected and service valves are open, air can be sucked into the refrigerant circuit which can cause anomalous high pressure resulting in burst or personal injury.
- **Be sure to tighten the flare nuts to specified torque using the torque wrench.**  
Tightening flare nuts with excess torque can cause burst and refrigerant leakage after a long period.
- **During pump down work, be sure to stop the compressor before closing service valves and removing connecting pipes.**  
If the connecting pipes are removed when the compressor is in operation and service valves are open, air can be sucked into the refrigerant circuit which can cause anomalous high pressure resulting in burst or personal injury.
- **In the event of refrigerant leakage during installation, be sure to ventilate the working area properly.**  
If the refrigerant comes into contact with naked flames, poisonous gases will be produced.
- **Electrical work must be carried out by the qualified electrician, strictly in accordance with national or regional electricity regulations.**  
Incorrect installation can cause electric shock, fire or personal injury.
- **Make sure that earth leakage breaker and circuit breaker of appropriate capacities are installed.**  
Circuit breaker should be able to disconnect all poles under over current. Absence of appropriate breakers can cause electric shock, personal injury or property damage.
- **Be sure to switch off the power source in the event of installation, maintenance or service.**  
If the power source is not switched off, there is a risk of electric shock, unit failure or personal injury.
- **Be sure to tighten the cables securely in terminal block and relieve the cables properly to prevent overloading the terminal blocks.**  
Loose connections or cable mountings can cause anomalous heat production or fire.
- **Do not process, splice or modify the power cable, or share the socket with other power plugs.**  
Improper power cable or power plug can cause fire or electric shock due to poor connection, insufficient insulation or over-current.
- **Do not perform any change in protective device or its setup condition yourself.**  
Changing protective device specifications can cause electric shock, fire or burst.
- **Be sure to clamp the cables properly so that they do not touch any internal component of the unit.**  
If cables touch any internal component, it can cause overheating and fire.
- **Be sure to install service cover properly.**  
Improper installation can cause electric shock or fire due to intrusion of dust or water.
- **Be sure to use the prescribed power and connecting cables for electrical work.**  
Using improper cables can cause electric leak or fire.
- **This appliance must be connected to main power source by means of a circuit breaker or switch with a contact separation of at least 3mm.**  
Improper electrical work can cause unit failure or personal injury.
- **When plugging this unit, a plug conforming to the standard IEC60884-1 must be used.**  
Using improper plug can cause electric shock or fire.
- **Be sure to connect the power source cable with power source properly.**  
Improper connection can cause intrusion of dust or water resulting in electric shock or fire.

#### CAUTION

- **Take care when carrying the unit by hand.**  
If the unit weight is more than 20kg, it must be carried by two or more persons. Do not carry the unit by the plastic straps. Always use the carry handle.
- **Do not install the outdoor unit in a location where insects and small animals can inhabit.**  
Insects and small animals can enter the electrical parts and cause damage resulting in fire or personal injury. Instruct the user to keep the surroundings clean.
- **If the outdoor unit is installed at height, make sure that there is enough space for installation, maintenance and service.**  
Insufficient space can result in personal injury due to falling from the height.
- **Do not install the unit near the location where neighbours are bothered by noise or air generating from the unit.**  
It can affect surrounding environment and cause a claim.
- **Do not install in the locations where unit is directly exposed to corrosive gases (like sulphide gas, chloride gas), sea breeze or salty atmosphere.**  
It can cause corrosion of heat exchanger and damage to plastic parts.
- **Do not install the unit close to the equipments that generate electromagnetic waves and/or high-harmonic waves.**  
Equipment such as inverters, standby generators, medical high frequency equipments and telecommunication equipments can affect the system, and cause malfunctions and breakdowns. The system can also affect medical equipment and telecommunication equipment, and obstruct its function or cause jamming.
- **Do not install the unit in the locations where:**
  - There are heat sources nearby.
  - Unit is directly exposed to rain or sunlight.
  - There is any obstacle which can prevent smooth air circulation from inlet and outlet side of the unit.
  - Unit is directly exposed to oil mist and steam such as kitchen.
  - Chemical substances like ammonia (organic fertilizer), calcium chloride (snow melting agent) and acid (sulfurous acid etc.), which can harm the unit, will generate or accumulate.
  - Drain water can not be discharged properly.
  - TV set or radio receiver is placed within 1m.
  - Height above sea level is more than 1000m.
 It can cause performance degradation, corrosion and damage of components, unit malfunction and fire.
- **Dispose of all packing materials properly.**  
Packing materials contain nails and wood which can cause personal injury. Keep the polybag away from children to avoid the risk of suffocation.
- **Do not put anything on the outdoor unit.**  
Object may fall causing property damage or personal injury.
- **Do not touch the aluminum fin of the outdoor unit.**  
Aluminum fin temperature is high during heating operation. Touching fin can cause burn.
- **Do not touch any refrigerant pipe with your hands when the system is in operation.**  
During operation the refrigerant pipes become extremely hot or extremely cold depending on the operating condition. Touching pipes can cause personal injury like burn (hot/cold).
- **Install isolator or disconnect switch on the power source wiring in accordance with the local codes and regulations.**  
The isolator should be locked in OFF state in accordance with EN60204-1.

## 1. ACCESSORIES AND TOOLS

Standard accessories (Supplied with indoor unit)				Locally procured parts		Tools for installation work	
(1) Installation board		1pc	(5) Wood screws (for remote control holder ø3.5 X 18mm)		2pcs	Plus headed driver	Pipe cutter
(2) Wireless remote control		1pc	(6) Batteries [R03 (AAA, Micro) 1.5V]		2pcs	Knife	Hole core drill (65mm in diameter)
(3) Remote control holder		1pc	(7) Air-cleaning filters		2pcs	Saw	Wrench key (Hexagon) [4mm]
(4) Tapping screws (for installation board ø4 X 25mm)		5pcs	(8) Insulation (#486 50 X 100 I3)		1pc	Tape measure	Flaring tool set*
						Torque wrench (14.0-62.0N·m (1.4-6.2kgf·m))	Gas leak detector*
						Plier	Pipe bender
							Flare adjustment gauge
							* Designed specifically for R32 or R410A

## 2. SELECTING INSTALLATION LOCATION

After getting customer's approval, select installation location according to following guidelines.

### 1. Indoor unit

- Where there is no obstruction to the airflow and where the cooled and heated air can be evenly distributed.
- A solid place where the unit or the wall will not vibrate.
- A place where there will be enough space for servicing.  
(Where space mentioned on the right side can be secured.)
- Where it is easy to conduct wiring and piping work.
- A place where unit is not directly exposed to sunlight or street light.
- A place where it can be easily drained.
- A place separated at least 1m away from the television or the radio.  
(To prevent interference to images and sounds.)
- A place where this unit is not affected by the high frequency equipment or electric equipment.
- Avoid installing this unit in place where there is much oil mist.
- A place where there is no electric equipment or household.
- Install the indoor unit on the wall where the height from the floor to the bottom of the unit is more than 180 cm.

### 2. Wireless remote control

- A place where the air-conditioner can receive the signal surely during operating the wireless remote control.
- A place where it is not affected by the TV, radio etc.
- Do not place where it is exposed to direct sunlight or near heat devices such as a stove.

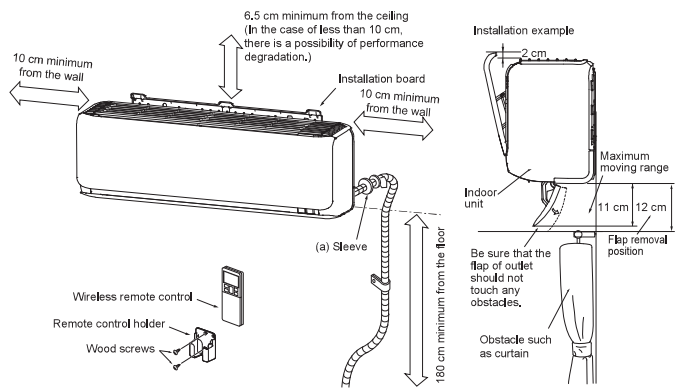

## 3. INSTALLING INSTALLATION BOARD

- Installation board should be installed on the wall which can support the weight of the indoor unit.
- Adjustment of the installation board in the horizontal direction is to be conducted with 5 screws in a temporary tightened state.
- With the standard hole as a center, adjust the board and level it.

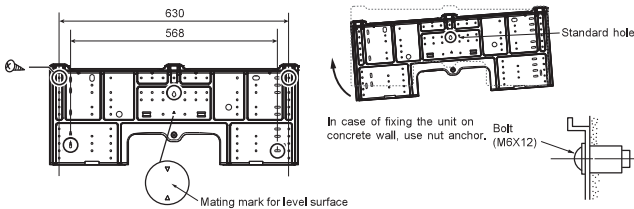

### CAUTION

Improper adjustment of the installation board can cause water leakage.

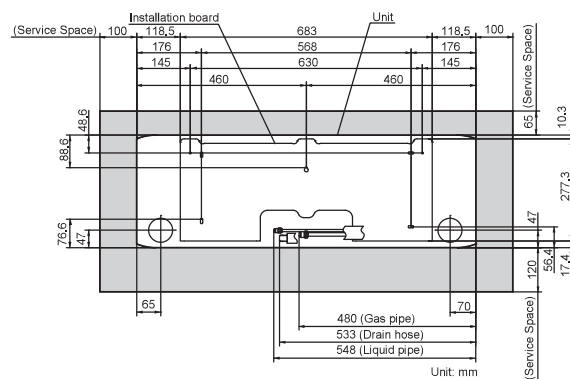

## 4. DRILLING HOLE AND FIXTURE OF SLEEVE

When drilling the wall that contains a metal lath, wire lath or metal plate, be sure to use sealing plate, sleeve and inclination plate (Locally procured parts).

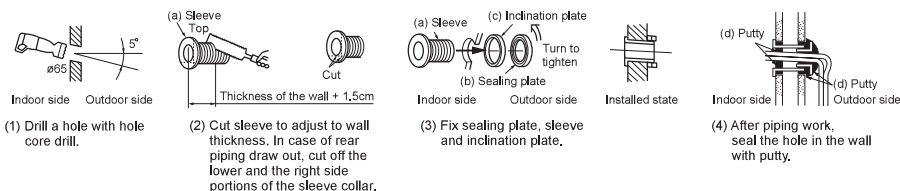

## 5. ELECTRICAL WIRING WORK

- Before installation, make sure that the power source complies with the air-conditioner's power specification.
- Carry out electrical wiring work according to following guidelines.

### 1. Preparing cable

- (1) Selecting cable  
Select the connecting cable in accordance with the specifications mentioned below.  
4-core\* 1.5mm<sup>2</sup> conformed with 60245 IEC57  
\* 1 Earth wire is included (Yellow/Green).
- (2) Arrange each wire length as shown below.  
Make sure that each wire is stripped 10mm from the end.

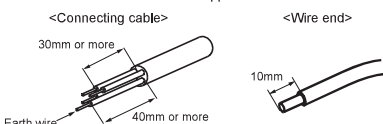

- (3) Attach round crimp-type terminal to each wire as shown in the below.  
Select the size of round crimp-type terminal after considering the specifications of terminal block and wire diameter.

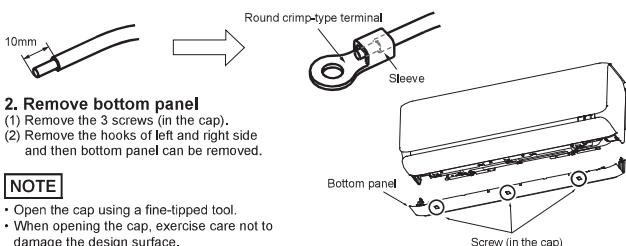

### 3. Connecting cable

- (1) Remove the terminal cover.
- (2) Remove the cable clamp.
- (3) Connect the connecting wires to the terminal block.
- (4) Fix the connecting cable by cable clamp.
- (5) Fix the terminal cover.

### NOTE

Take care not to confuse the terminal numbers for indoor and outdoor connections.

The screw of the terminal cover is tightened securely.

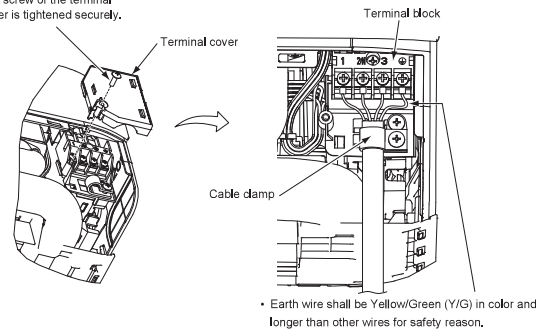

### WARNING

Incorrect wiring connection can cause malfunction or fire.

## 6. FORMING PIPING AND DRAIN HOSE

### 1. Forming piping

Piping is possible in the right, rear, downward, left, left rear or left downward direction.

#### NOTE

Sufficient care must be taken not to damage the panels when connecting pipes.

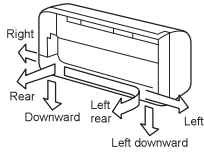

Cut out the panel smoothly along the line in case of side or bottom piping.

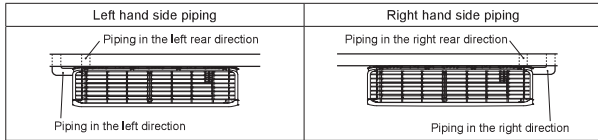
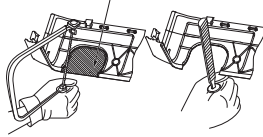

### Forming of pipings

- Hold the bottom of the piping and fix direction before stretching it and shaping it.

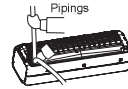

### Taping of the exterior

- Tape only the portion that goes through the wall.
- Always tape the wiring with the piping.



### 2. Drain change procedures

- (1) Remove the screw and drain hose.
- (2) Remove the drain cap by hand or pliers.
- (3) Insert the drain cap which was removed at procedure (2) securely using a hexagonal wrench etc.
- (4) Install the drain hose and screw securely.

(1)

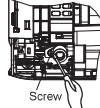

(2)

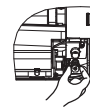

(3)



(4)



#### CAUTION

Incorrect installation of drain hose and cap can cause water leakage.

## 7. DRAINAGE WORK

- Arrange the drain hose in a downward angle.
- Avoid the following drain piping.

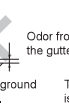

Higher than specified

The drain hose tip is in water.

Wavy

The gap to the ground is 5 cm or less.

Odor from the gutter

The drain hose tip is in the gutter.

- Pour water to the drain pan located under the heat exchanger, and ensure that the water is discharged outdoor.
- When extended drain hose is present inside the room, insulate it securely with heat insulator available in the market.

Since this air-conditioner is designed to collect dew drops on the rear surface to the drain pan, do not install the connecting wire above the gutter.

#### CAUTION

Incorrect drainage work can cause water leakage.

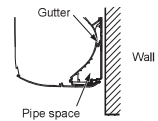

## 8. INSTALLING INDOOR UNIT

### Installing the indoor unit to installation board

- (1) Pass the pipe through the hole in the wall, and hook the upper part of the indoor unit to the installation board.



- (2) Gently push the lower part to fix the indoor unit base lower latch to installation board.



- (3) Install the latches of the bottom panel (7 locations). Secure the bottom panel with the 3 screws (in the cap).

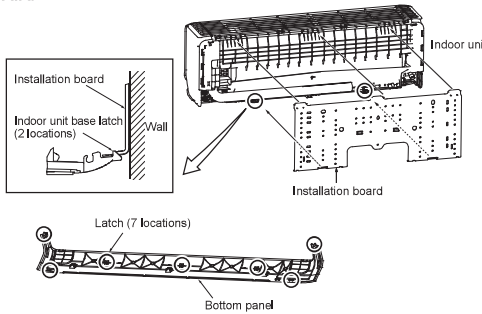

### Removing the indoor unit from installation board

- (1) Remove the bottom panel. (Refer to 5.2)
- (2) Pull the indoor unit base latch downward, (both right and left hand sides). (The indoor unit base latch can be removed from the installation board.)
- (3) Push up the indoor unit upward so that it can be removed from installation board.

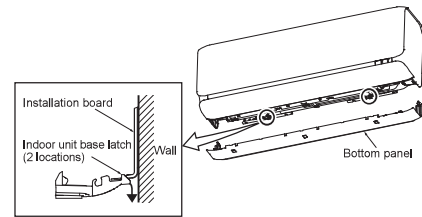

## 9. CONNECTING PIPING WORK

### 1. Preparation of connecting pipe

#### 1.1. Selecting connecting pipe

Select connecting pipe according to the following table.

	Model SRK20/25/35	Model SRK50/60
Gas pipe	ø9.52	ø12.7
Liquid pipe	ø6.35	ø6.35

- Pipe wall thickness must be greater than or equal to 0.8 mm.
- Pipe material must be O-type (Phosphorus deoxidized seamless copper pipe ICS 23.040.15, ICS 77.150.30).

#### 1.2. Cutting connecting pipe

- (1) Cut the connecting pipe to the required length with pipe cutter.
- (2) Hold the pipe downward and remove the burrs. Make sure that no foreign material enters the pipe.
- (3) Cover the connecting pipe ends with the tape.

### 2. Piping work

#### 2.1. Flaring pipe

- (1) Take out flare nuts from the service valves of indoor unit and engage them onto connecting pipes.
- (2) Flare the pipes according to table and figure shown below.

Flare dimensions for R32 are different from those for conventional refrigerant. Although it is recommended to use the flaring tools designed specifically for R32 or R410A, conventional flaring tools can also be used by adjusting the measurement of protrusion B with a flare adjustment gauge.

Copper pipe outer diameter	A <sub>0</sub> -0.4	Copper pipe outer diameter	Rigid (clutch) type	
			R32 or R410A	Conventional
ø6.35	9.1	ø6.35		
ø9.52	13.2	ø9.52	0-0.5	1.0-1.5
ø12.7	16.6	ø12.7		

#### 2.2 Connecting pipes

- (1) Connect pipes on both liquid and gas sides.
- (2) Tighten nuts to specified torque shown in the table below.

Service valve size (mm)	Tightening torque (N·m)
ø6.35 (1/4")	14-18
ø9.52 (3/8")	34-42
ø12.7 (1/2")	49-61

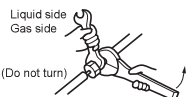

#### CAUTION

- Do not apply refrigerating machine oil to the flared surface. It can cause refrigerant leakage.
- Do not apply excess torque to the flared nuts. The flared nuts may crack resulting in refrigerant leakage.

### 3. Heating and condensation prevention

- (1) Dress the connecting pipes (both liquid and gas pipes) with insulation to prevent it from heating and dew condensation. Use the heat insulating material which can withstand 120°C or higher temperature. Make sure that insulation is wrapped tightly around the pipes and no gap is left between them.
- (2) Wrap the refrigerant pipings of indoor unit with indoor unit heat insulation using tape.
- (3) Cover the flare-connected joints (indoor side) with the indoor unit heat insulation and wrap it with an insulation pad (standard accessory provided with indoor unit).
- (4) Wrap the connecting pipes, connecting cable and drain hose with the tape.

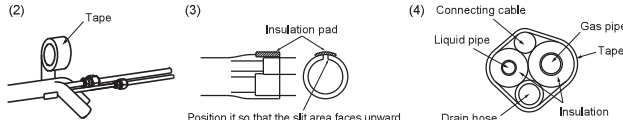

#### NOTE

Locations where relative humidity exceeds 70%, both liquid and gas pipes need to be dressed with 20mm or thicker heat insulation materials.

#### CAUTION

- Improper insulation can cause condensate(water) formation during cooling operation. Condensate can leak or drip causing damage to household property.
- Poor heat insulating capacity can cause pipe outer surface to reach high temperature during heating operation. It can cause cable deterioration and personal injury.

### 4. Finishing work

- (1) Make sure that the exterior portion of connecting pipes, connecting cable and drain hose is wrapped properly with tape. Shape the connecting pipes to match with the contours of the pipe assembly route.
- (2) Fix the pipe assembly with the wall using clamps and screws. Pipe assembly should be anchored every 1.5m or less to isolate the vibration.
- (3) Install the service cover securely. Water may enter the unit if service cover is not installed properly, resulting in unit malfunction and failure.

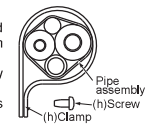

#### WARNING (only for R32)

- To avoid the risk of fire or explosion, the flared connection must/shall be installed outdoors.
- Reusable mechanical connectors and flared joints are not allowed indoors.

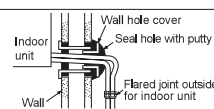

#### CAUTION

Make sure that the connecting pipes do not touch the components within the unit. If pipes touch the internal components, it may generate abnormal sounds and/or vibrations.

### 10. HOW TO OPEN, CLOSE, REMOVE AND INSTALL THE AIR INLET PANEL

- 1. Open**  
Pull the air inlet panel at both ends of lower part and release latches, then pull up the panel until you feel resistance.  
(The panel stops at approx. 60° open position)
- 2. Close**  
Hold the panel at both ends of lower part, lower it downward slowly, then push it slightly until the latch works.
- 3. Removing**  
Open the panel by 80° (as shown in the right illustration) and then pull it forward.
- 4. Installing**  
Insert the panel arm into the slot on the front panel from the position shown in right illustration, hold the panel at both ends of lower part, lower it downward slowly, then push it slightly until the latch works.

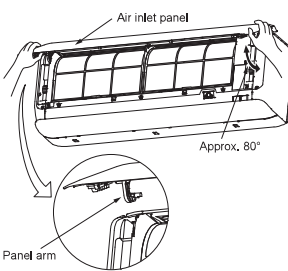

**NOTE**

- When carrying out maintenance, handle the air inlet panel with care.

### 11. HOW TO REMOVE AND INSTALL THE SIDE AND FRONT PANEL

- 1. Side panel (R/L)**
  - 1.1. Removing**
    - Remove the 2 screws.
    - Remove the 3 latches and then side panel can be removed.
  - 1.2. Installing**
    - Cover the unit with the side panel and fix 3 latches.
    - Secure the side panel with the 2 screws.
- 2. Front panel**
  - 2.1. Removing**
    - Remove the side panel (R/L), the air inlet panel, the air filters and the bottom panel.
    - Remove the 3 screws.
    - Remove the 4 upper latches and then front panel can be removed.
  - 2.2. Installing**
    - Cover the unit with the front panel and fix 4 upper latches.
    - Secure the front panel with the 3 screws.
    - Install the bottom panel, the side panel (R/L), the air inlet panel and the air filters.

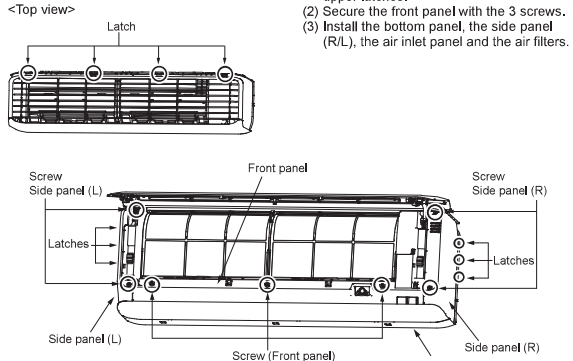

### 12. INSTALLING WIRELESS REMOTE CONTROL

**Mount the batteries**

- Slide and take out the cover of backside.
- Mount the batteries [R03 (AAA, Micro), x2 pieces] in the body properly.  
(Fit it poles with the indication marks + & -)
- Set the cover again.

**Installing remote control holder**

- Select the place where the unit can receive signals.
- Fix the holder to pillar or wall with wood screws.

**NOTE**

- Do not use new and old batteries together.
- In case the unit is not operated for a long time, take out the batteries

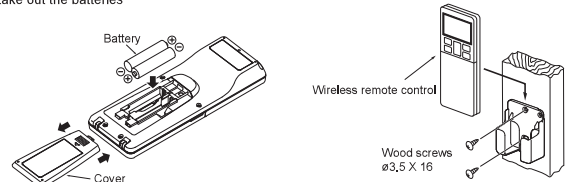

### 16. INSTALLATION CHECK AND TEST RUN

After finishing the installation work, check the following points again before turning on the power. Conduct a test run and ensure that the unit operates properly. At the same time, explain to the customer how to use the unit and how to take care of the unit following the user's manual.

Before test run	Test run
Power source voltage complies with the rated voltage of air-conditioner.	Indoor unit receives signal of wireless remote control.
Earth leakage breaker and circuit breaker are installed.	Air-conditioning operation is normal.
Power cable and connecting cable are securely fixed to the terminal block.	There is no abnormal noise.
Both liquid and gas service valves are fully open.	Water drains out smoothly.
No gas leaks from the joints of the service valves.	Display of wireless remote control is normal.
Indoor and outdoor side pipe joints have been insulated.	
Hole on the wall is completely sealed with putty.	
Drain hose and cap are installed properly.	
Screw of the terminal cover is tightened securely.	

**After test run**

Explain the operating and maintenance methods to the user according to the user's manual.	
Keep this installation manual together with user's manual.	

**NOTE**

During restart or change in operation mode, the unit will not start operating for approximately 3 minutes. This is to protect the unit and it is not malfunction.

### 13. INSTALLING TWO AIR-CONDITIONERS IN THE SAME ROOM

In case two air-conditioners are installed in the same room, apply this setting so that one unit can be operated with only one wireless remote control.

**Setting one wireless remote control**

- Slide and take out the cover and batteries.
- Cut the switching line next to the battery with wire cutters.
- Set the batteries and cover again.

**Setting one indoor unit**

- Turn off the power source and turn it on after 1 minute.
- Send the signal by pressing the ACL switch on the wireless remote control that was set according to the procedure described on the above side.
- Check that the reception buzzer sound "Peep" is emitted from the indoor unit. Since the signal is sent about 6 seconds after the ACL switch is pressed, point the wireless remote control to the indoor unit for a while.

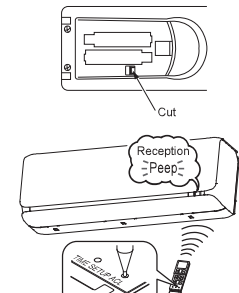

**NOTE**

If no reception buzzer is emitted, restart the setting from the beginning.

### 14. TERMINAL CONNECTION FOR AN INTERFACE

To install wired remote control, superlink etc., interface kit is needed.

- Remove the air inlet panel, bottom panel and side panel (R).
- Remove the control cover. (Remove the screw.)
- There is a terminal (respectively marked with CNS) for the indoor control board. While connecting an interface, connect to the respective terminal securely with the connection harness supplied with the option "Interface kit SC-B1KN-E and SC-B1KN2-E" and fasten the connection harness onto the indoor control box with the clamp and screw supplied with the kit.
- Hook to fix the interface kit to the 2 latches on side panel (L).  
For more details, refer to the user's manual of "Interface kit SC-B1KN-E and SC-B1KN2-E".

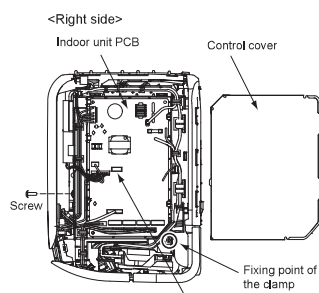
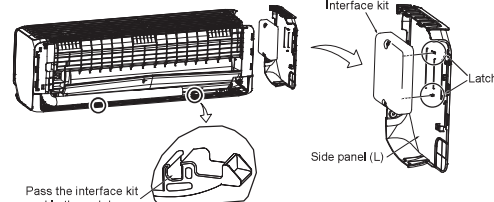



### 15. PUMP DOWN WORK

For the environmental protection, be sure to pump down when relocating or disposing of the unit. Pump down is the method of recovering refrigerant from the indoor unit to the outdoor unit before the connecting pipes are removed from the unit. When pump down is carried out, forced cooling operation is needed.

**Forced cooling operation**

- Turn off the power source and turn it on again after 1 minute. The air inlet panel and flap open and close.
- After the air inlet panel closes, press the ON/OFF button continuously for at least 5 seconds. Then operation will start.



For the detail of pump down, refer to the installation manual of outdoor unit.

**(2) Installation of outdoor unit**

RWC012A063B

Model SRC20,25,35,40,50,60ZSX-W  
SRC20,25,35ZSX-WA  
R32 REFRIGERANT USED

• This installation manual deals with an outdoor unit installation only. For an indoor unit installation, refer to page 52.

**SAFETY PRECAUTIONS**

- Before installation, read the "SAFETY PRECAUTIONS" carefully and strictly follow it during the installation work in order to protect yourself.
  - The precautionary items mentioned below are distinguished into two levels, **WARNING** and **CAUTION**.
  - WARNING** Indicates a potentially hazardous situation which, if not avoided, can result in serious consequences such as death or severe injury.
  - CAUTION** Indicates a potentially hazardous situation which, if not avoided, can result in personal injury or property damage.
- Both mention the important items to protect your health and safety. Therefore, strictly follow them by any means.

**WARNING**

- **Be sure to use only for residential purpose.**  
If this unit is installed in inferior environment such as machine shop, vehicle (like ship), warehouse, etc., it can malfunction.
- **Installation must be carried out by the qualified installer completely in accordance with the installation manual.**  
Installation by non qualified person or incorrect installation can cause serious troubles such as water leak, electric shock, fire and personal injury.
- **Be sure to wear protective goggles and gloves while performing installation work.**  
Improper safety measures can result in personal injury.
- **Use the original accessories and the specified components for the installation.**  
Using parts other than those prescribed may cause water leak, electric shock, fire and personal injury.
- **Do not install the unit near the location where leakage of flammable gases can occur.**  
If leaked gases accumulate around the unit, it can cause fire resulting in property damage and personal injury.
- **When installing the unit in small rooms, make sure that refrigerant density does not exceed the limit (Reference: ISO5149) in the event of leakage.**  
If refrigerant density exceeds the limit, consult the dealer and install the ventilation system. Otherwise lack of oxygen can occur resulting in serious accident.
- **Install the unit in a location where unit will remain stable, horizontal and free of any vibration transmission.**  
Unsuitable installation location can cause the unit to fall resulting in material damage and personal injury.
- **Do not run the unit with removed panels or protections.**  
Touching rotating equipments, hot surfaces or high voltage parts can cause personal injury due to entrapment, burn or electric shock.
- **This unit is designed specifically for R32.**  
Using any other refrigerant can cause unit failure and personal injury.
- **Do not vent R32 into atmosphere.**  
R32 is a fluorinated greenhouse gas with a Global Warming Potential(GWP)=675.
- **Make sure that no air enters the refrigerant circuit when the unit is installed and removed.**  
If air enters the refrigerant circuit, the pressure in the refrigerant circuit will become too high, which can cause burst and personal injury.
- **Be sure to use the prescribed pipes, flare nuts and tools for R32 or R410A.**  
Using existing parts (for R22 or R407C) can cause refrigerant circuit burst resulting in unit failure and personal injury.
- **Be sure to connect both liquid and gas connecting pipes properly before operating the compressor.**  
**Do not open the liquid and gas operation valves before completing piping work, and evacuation.**  
If the compressor is operated when connecting pipes are not connected and operation valves are open, air can be sucked into the refrigerant circuit which can cause anomalous high pressure resulting in burst or personal injury.
- **Be sure to tighten the flare nuts to specified torque using the torque wrench.**  
Tightening flare nuts with excess torque can cause burst and refrigerant leakage after a long period.
- **During pump down work, be sure to stop the compressor before closing service valves and removing connecting pipes.**  
If the connecting pipes are removed when the compressor is in operation and service valves are open, air can be sucked into the refrigerant circuit which can cause anomalous high pressure resulting in burst or personal injury.
- **In the event of refrigerant leakage during installation, be sure to ventilate the working area properly.**  
If the refrigerant comes into contact with naked flames, poisonous gases will be produced.
- **Electrical work must be carried out by the qualified electrician, strictly in accordance with national or regional electricity regulations.**  
Incorrect installation can cause electric shock, fire or personal injury.
- **Make sure that earth leakage breaker and circuit breaker of appropriate capacities are installed.**  
Circuit breaker should be able to disconnect all poles under over current. Absence of appropriate breakers can cause electric shock, personal injury or property damage.
- **Be sure to switch off the power source in the event of installation, maintenance or service.**  
If the power source is not switched off, there is a risk of electric shock, unit failure or personal injury.
- **Be sure to tighten the cables securely in terminal block and relieve the cables properly to prevent overloading the terminal blocks.**  
Loose connections or cable mountings can cause anomalous heat production or fire.
- **Do not process, splice or modify the power cable, or share the socket with other power plugs.**  
Improper power cable or power plug can cause fire or electric shock due to poor connection, insufficient insulation or over-current.
- **Do not perform any change in protective device or its setup condition yourself.**  
Changing protective device specifications can cause electric shock, fire or burst.
- **Be sure to clamp the cables properly so that they do not touch any internal component of the unit.**  
If cables touch any internal component, it can cause overheating and fire.
- **Be sure to install service cover properly.**  
Improper installation can cause electric shock or fire due to intrusion of dust or water.
- **Be sure to use the prescribed power and connecting cables for electrical work.**  
Using improper cables can cause electric leak or fire.
- **This appliance must be connected to main power source by means of a circuit breaker or switch with a contact separation of at least 3mm.**  
Improper electrical work can cause unit failure or personal injury.
- **When plugging this unit, a plug conforming to the standard IEC60884-1 must be used.**  
Using improper plug can cause electric shock or fire.
- **Be sure to connect the power source cable with power source properly.**  
Improper connection can cause intrusion of dust or water resulting in electric shock or fire.

**CAUTION**

- **Take care when carrying the unit by hand.**  
If the unit weight is more than 20kg, it must be carried by two or more persons. Do not carry the unit by the plastic straps. Always use the carry handle.
- **Do not install the outdoor unit in a location where insects and small animals can inhabit.**  
Insects and small animals can enter the electrical parts and cause damage resulting in fire or personal injury. Instruct the user to keep the surroundings clean.
- **If the outdoor unit is installed at height, make sure that there is enough space for installation, maintenance and service.**  
Insufficient space can result in personal injury due to falling from the height.
- **Do not install the unit near the location where neighbours are bothered by noise or air generating from the unit.**  
It can affect surrounding environment and cause a claim.
- **Do not install in the locations where unit is directly exposed to corrosive gases (like sulphide gas, chloride gas), sea breeze or salty atmosphere.**  
It can cause corrosion of heat exchanger and damage to plastic parts.
- **Do not install the unit close to the equipments that generate electromagnetic waves and/or high-harmonic waves.**  
Equipment such as inverters, standby generators, medical high frequency equipments and telecommunication equipments can affect the system, and cause malfunctions and breakdowns. The system can also affect medical equipment and telecommunication equipment, and obstruct its function or cause jamming.
- **Do not install the unit in the locations where:**
  - There are heat sources nearby.
  - Unit is directly exposed to rain or sunlight.
  - There is any obstacle which can prevent smooth air circulation from inlet and outlet side of the unit.
  - Unit is directly exposed to oil mist and steam such as kitchen.
  - Chemical substances like ammonia (organic fertilizer), calcium chloride (snow melting agent) and acid (sulfurous acid etc.), which can harm the unit, will generate or accumulate.
  - Drain water can not be discharged properly.
  - TV set or radio receiver is placed within 1m.
  - Height above sea level is more than 1000m.
- **Dispose of all packing materials properly.**  
Packing materials contain nails and wood which can cause personal injury. Keep the polybag away from children to avoid the risk of suffocation.
- **Do not put anything on the outdoor unit.**  
Object may fall causing property damage or personal injury.
- **Do not touch the aluminum fin of the outdoor unit.**  
Aluminium fin temperature is high during heating operation. Touching fin can cause burn.
- **Do not touch any refrigerant pipe with your hands when the system is in operation.**  
During operation the refrigerant pipes become extremely hot or extremely cold depending on the operating condition. Touching pipes can cause personal injury like burn (hot/cold).
- **Install isolator or disconnect switch on the power source wiring in accordance with the local codes and regulations.**  
The isolator should be locked in OFF state in accordance with EN60204-1.

**1. ACCESSORIES AND TOOLS**

Standard accessories (Supplied with outdoor unit)		Q'ty	Locally procured parts		Tools for installation work		
(1)	Drain grommet	4	(a)	Anchor bolt(M10-M12)×4 pcs	Plus headed driver	Spanner wrench	Vacuum pump*
(2)	Drain elbow	1	(b)	Putty	Knife	Torque wrench [14,0-62,0N·m(1.4-6.2kgf·m)]	Gauge manifold *
			(c)	Electrical tape	Saw	Wrench key (Hexagon) [4mm]	Charge hose *
			(d)	Connecting pipe			Vacuum pump adapter* (Anti-reverse flow type)
			(e)	Connecting cable	Tape measure	Flaring tool set *	Gas leak detector *
			(f)	Power cable	Pipe cutter	Flare adjustment gauge	
			(g)	Clamp and screw (for finishing work)			

\*Not included for SRC20, 25, or 35ZSX-WA.

\*Designed specifically for R32 or R410A

## 2. OUTDOOR UNIT INSTALLATION

### Note as a unit designed for R32

- Do not use any refrigerant other than R32. R32 will rise to pressure about 1.6 times higher than that of a conventional refrigerant. A cylinder containing R32 has a light blue indication mark on the top.
- Do not use a charge cylinder. The use of a charge cylinder will cause the refrigerant composition to change, which results in performance degradation.
- In charging refrigerant, always take it out from a cylinder in the liquid phase.
- All indoor units must be models designed exclusively for R32. Check connectable indoor unit models in a catalog, etc. (A wrong indoor unit, if connected into the system, will impair proper system operation)

### 1. Haulage

- Always carry or move the unit with two or more persons.
  - The right hand side of the unit as viewed from the front (outlet side) is heavier.
- A person carrying the right hand side must take care of this fact. A person carrying the left hand side must hold the handle provided on the front panel of the unit with his right hand and the corner column section of the unit with his left hand.

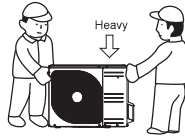

### CAUTION

When a unit is hauled, take care of its gravity center position which is shifted towards right hand side. If the unit is not hauled properly, it can go off balance and fall resulting in serious injury.

### 2. Selecting the installation location

Select the suitable installation location where:

- Unit will be stable, horizontal and free of any vibration transmission.
- There is no obstacle which can prevent smooth air circulation from inlet and outlet side of the unit.
- There is enough space for service and maintenance of unit.
- Neighbours are not bothered by noise or air generating from the unit.
- Outlet air of the unit does not blow directly to animals or plants.
- Drain water can be discharged properly.
- There is no risk of flammable gas leakage.
- There are no other heat sources nearby.
- Unit is not directly exposed to rain or sunlight.
- Unit is not directly exposed to oil mist and steam.
- Chemical substances like ammonia (organic fertilizer), calcium chloride (snow melting agent) and acid (sulfurous acid etc.), which can harm the unit, will not generate or accumulate.
- Unit is not directly exposed to corrosive gases (like sulphide gas, chloride gas), sea breeze or salty atmosphere.
- No TV set or radio receiver is placed within 1m.
- Unit is not affected by electromagnetic waves and/or high-harmonic waves generated by other equipments.
- Strong wind does not blow against the unit outlet.
- Heavy snowfalls do not occur (If installed, provide proper protection to avoid snow accumulation).

### NOTE

If the unit is installed in the area where there is a possibility of strong wind or snow accumulation, the following measures are required.

#### (1) Location of strong wind

- Place the unit with its outlet side facing the wall.
- Place the unit such that the direction of air from the outlet gets perpendicular to the wind direction.

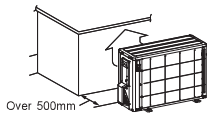

#### (2) Location of snow accumulation

- Install the unit on the base so that the bottom is higher than snow cover surface.
- Install the unit under eaves or provide the roof on site.

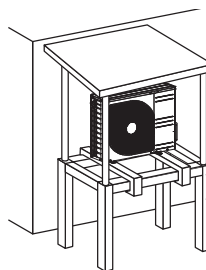

### 3. Installation space

- There must be 1 meter or larger space between the unit and the wall in at least 1 of the 4 sides. Walls surrounding the unit from 4 sides is not acceptable. The wall height on the outlet side should be 1200 mm or less. Refer to the following figure and table for details.

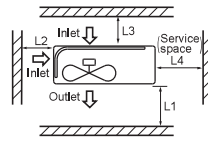

Size	Example installation (mm)			
	I	II	III	IV
L1	Open	280	280	180
L2	100	75	Open	Open
L3	100	80	80	80
L4	250	Open	250	Open

### NOTE

When more than one unit are installed side by side, provide a 250mm or wider interval between them as a service space.

### CAUTION

When more than one unit are installed in parallel directions, provide sufficient inlet space so that short-circuiting may not occur.

### 4. Drain piping work (If necessary)

Carry out drain piping work by using a drain elbow and a drain grommet supplied separately as accessories if condensed water needs to be drained out.

- Install drain elbow and drain grommet.
- Seal around the drain elbow and drain grommet with putty or adequate caulking material.

<SRC20/25/35/40/50/60ZSX-W>

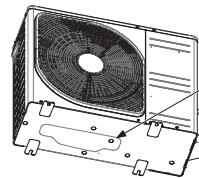

Do not put a grommet on this hole. This is a supplementary drain hole to discharge drain water, when a large amount of it is gathered.

### CAUTION

Do not use drain elbow and drain grommet if there is a possibility to have several consecutive days of sub zero temperature. (There is a risk of drain water freezing inside and blocking the drain.)

<SRC20/25/35ZSX-WA>

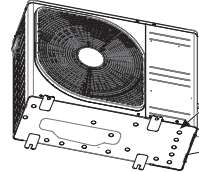

Do not block the drain holes when installing the outdoor unit.

### 5. Installation

- Install the unit on a flat level base.
- While installing the unit, keep space and fix the unit's legs with 4 anchor bolts as shown in the figure below. The protrusion of an anchor bolt from the foundation surface must be kept within 15mm.

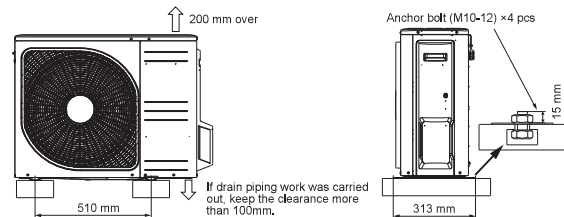

### CAUTION

- Install the unit properly so that it does not fall over during earthquake, strong wind, etc.
- Make sure that unit is installed on a flat level base. Installing unit on uneven base may result in unit malfunction.

## 3. PREPARATION FOR WORK

### 1. Removing service cover

Remove the screw. Slide service cover downwards and remove it.

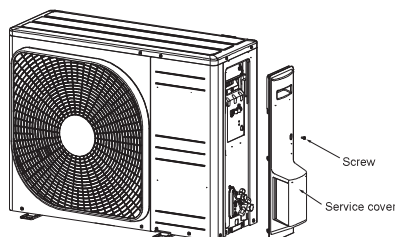

### 2. Removing terminal cover

Remove the screw and take out terminal cover.

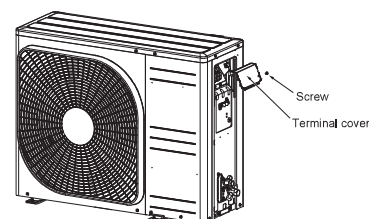

## 4. CONNECTING PIPING WORK

### 1. Restrictions on unit installation

Abide by the following restrictions on unit installation. Improper installation can cause compressor failure or performance degradation.

	Dimensional restrictions	
	Model SRC20/25/35	Model SRC40/50/60
Connecting pipe length(L)	25m or less	30m or less
Elevation difference between indoor and outdoor units(H)*	15m or less	20m or less

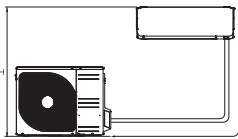

\* Outdoor unit installation position can be higher as well as lower than the indoor unit installation position.

### 2. Preparation of connecting pipe

#### 2.1. Selecting connecting pipe

Select connecting pipe according to the following table.

	Model SRC20/25/35	Model SRC40/50/60
Gas pipe	ø9.52	ø12.7
Liquid pipe	ø6.35	ø6.35

- Pipe wall thickness must be greater than or equal to 0.8 mm.
- Pipe material must be O-type (Phosphorus deoxidized seamless copper pipe ICS 23.040.15, ICS 77.150.30).

#### NOTE

If it is required to reuse the existing connecting pipe system, refer to 5. UTILIZATION OF EXISTING PIPE.

#### 2.2. Cutting connecting pipe

- (1) Cut the connecting pipe to the required length with pipe cutter.
- (2) Hold the pipe downward and remove the burrs. Make sure that no foreign material enters the pipe.
- (3) Cover the connecting pipe ends with the tape.

#### 3. Piping work

Check that both liquid and gas service valves are fully closed. Carry out the piping work with service valves fully closed.

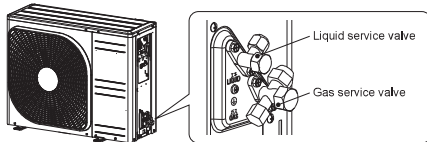

#### 3.1. Flaring pipe

- (1) Take out flare nuts from the service valves of outdoor unit and engage them onto connecting pipes.
  - (2) Flare the pipes according to table and figure shown below.
- Flare dimensions for R32 are different from those for conventional refrigerant. Although it is recommended to use the flaring tools designed specifically for R32 or R410A, conventional flaring tools can also be used by adjusting the measurement of protrusion B with a flare adjustment gauge.

Copper pipe outer diameter	A <sub>0</sub> -0.4	Rigid (clutch) type	
		R32 or R410A	Conventional
ø6.35	9.1	ø-0.5	1.0-1.5
ø9.52	13.2		
ø12.7	16.6		

#### 3.2. Connecting pipes

- (1) Connect pipes on both liquid and gas sides.
- (2) Tighten nuts to specified torque shown in the table below.

Service valve size (mm)	Tightening torque (N-m)
ø6.35 (1/4")	14-18
ø9.52 (3/8")	34-42
ø12.7 (1/2")	49-61

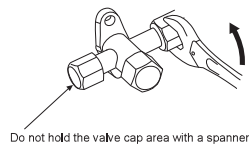

#### CAUTION

- Do not apply refrigerating machine oil to the flared surface. It can cause refrigerant leakage.
- Do not apply excess torque to the flared nuts. The flared nuts may crack resulting in refrigerant leakage.

### 4. Evacuation

- (1) Connect vacuum pump to gauge manifold. Connect charge hose of gauge manifold to service port of outdoor unit.
- (2) Run the vacuum pump for at least one hour after the vacuum gauge shows -0.1MPa (-76cm Hg).
- (3) Confirm that the vacuum gauge indicator does not rise even if the system is left for 15 minutes or more. Vacuum gauge indicator will rise if the system has moisture left inside or has a leakage point. Check the system for the leakage point. If leakage point is found, repair it and return to (1) again.
- (4) Close the Handle Lo and stop the vacuum pump. Keep this state for a few minutes to make sure that the compound pressure gauge pointer does not swing back.
- (5) Remove valve caps from liquid service valve and gas operation valve.
- (6) Turn the liquid service valve's rod 90 degree counterclockwise with a hexagonal wrench key to open valve. Close it after 5 seconds, and check for gas leakage. Using soapy water, check for gas leakage from indoor unit's flare and outdoor unit's flare and valve rods. Wipe off all the water after completing the check.
- (7) Disconnect charging hose from gas service valve's service port and fully open liquid and gas service valves. (Do not attempt to turn valve rod beyond its stop.)
- (8) Tighten service valve caps and service port cap to the specified torque shown in the table below.

Service valve size (mm)	Service valve cap tightening torque (N-m)	Service port cap tightening torque (N-m)
ø6.35 (1/4")	20-30	10-12
ø9.52 (3/8")		
ø12.7 (1/2")	25-35	

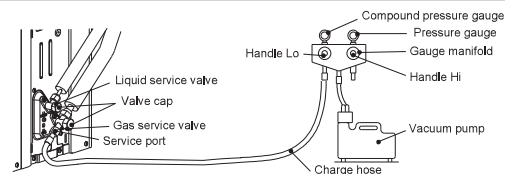

#### CAUTION

To prevent vacuum pump oil from entering into the refrigerant system, use a counterflow prevention adapter.

### 5. Additional refrigerant charge

Additional refrigerant charge is required only when connecting pipe length exceeds 15 m.

#### 5.1 Calculating additional refrigerant charge

Additional refrigerant charge can be calculated using the formula given below.  
Additional refrigerant charge (g) = { Connecting pipe length (m) - Factory charged length 15 (m) } x 20 (g/m)

#### NOTE

- If additional refrigerant charge calculation result is negative, there is no need to remove the refrigerant.
- If refrigerant recharge is required for the unit with connecting pipe length 15m or shorter, charge the factory charged amount as shown in the table below.
- The maximum refrigerant charge amount is designed as shown in the table below.

	Model SRC 20/25/35	Model SRC40/50/60
The factory refrigerant charge amount(kg)	1.20	1.30
The maximum refrigerant charge amount(kg)	1.40	1.60

#### 5.2 Charging refrigerant

- (1) Charge the R32 refrigerant in liquid phase from service port with both liquid and gas service valves shut. Since R32 refrigerant must be charged in the liquid phase, make sure that refrigerant is discharged from the cylinder in the liquid phase all the time.
- (2) When it is difficult to charge a required refrigerant amount, fully open both liquid and gas service valves and charge refrigerant, while running the unit in the cooling mode. When refrigerant is charged with the unit being run, complete the charge operation within 30 minutes.
- (3) Write the additional refrigerant charge calculated from the connecting pipe length on the label attached on the service cover.

#### CAUTION

- Running the unit with an insufficient quantity of refrigerant for a long time can cause unit malfunction.
- Do not charge more than the maximum refrigerant amount. It can cause unit malfunction.

## 5. UTILIZATION OF EXISTING PIPE

(1) Check whether an existing pipe system is reusable or not by using the following flow chart.

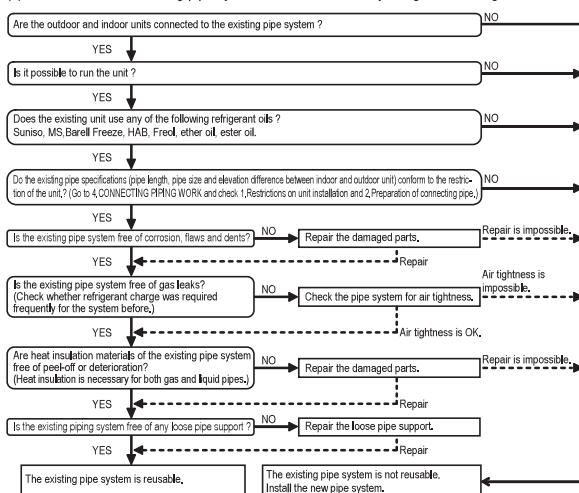

#### NOTE

- Consult with our distributor in the area, if you need to recover refrigerant and charge it again.
- (2) Clean the existing pipe system according to the procedure given below.
  - (a) Carry out forced cooling operation of existing unit for 30 minutes. For 'Forced cooling operation' refer to the indoor unit installation manual.
  - (b) Stop the indoor fan and carry out forced cooling operation for 3 minutes (Liquid return).
  - (c) Close the liquid service valve of the outdoor unit and carry out pump down operation (Refer to 6. PUMP DOWN).
  - (d) Blow with nitrogen gas. If discolored refrigeration oil or any foreign matter is discharged by the blow, wash the pipe system or install a new pipe system.
- (3) Remove the flare nuts from the existing pipe system. Go back to 4.CONNECTING PIPING WORK and proceed to step 2.2 Cutting connecting pipe.

#### CAUTION

- Do not use the old flare nuts (of existing unit). Make sure that the flare nuts supplied with the (new) outdoor unit are used.
- If the flared / compression connection to the indoor unit is located inside the house / room then this pipework can't be reused.

\* If the existing piping is specified as liquid pipe ø9.52 or gas pipe ø12.7, refer to the following. (SRC40,50 and 60 only)

<Table of pipe size restrictions>

Additional charge volume per meter of pipe		0.054kg/m
Pipe size	Liquid pipe	ø9.52
	Gas pipe	ø12.7
Maximum one-way pipe length		10
Length covered without additional charge		5

Additional charge amount (kg) = (Main pipe length (m) - Length covered without additional charge shown in the table (m)) X Additional charge amount per meter of pipe shown in the table (kg/m)

## 6. PUMP DOWN

- Connect charge hose of gauge manifold to service port of outdoor unit.
- Close the liquid service valve with hexagonal wrench key.
- Fully open the gas service valve with hexagonal wrench key.
- Carry out forced cooling operation (For forced cooling operation procedure, refer to indoor unit installation manual).
- When the low pressure gauge becomes 0.01MPa, close the gas service valve and stop forced cooling operation.

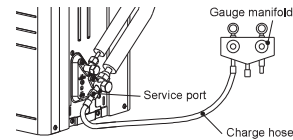

## 7. ELECTRICAL WIRING WORK

### ⚠ WARNING

- Make sure that all the electrical work is carried out in accordance with the national or regional electrical standards.
- Make sure that the earth leakage breaker and circuit breaker of appropriate capacities are installed (Refer to the table given below).
- Do not turn on the power until the electrical work is completed.
- Do not use a condensive capacitor for power factor improvement under any circumstances. (It does not improve power factor. Moreover, it can cause an abnormal overheat accident).

#### Breaker specifications

Model	Phase	Earth leakage breaker	Circuit breaker
SRC20/25/35	Single phase	Leakage current: 30mA, 0.1sec or less	Over current: 16A
SRC40/50/60			Over current: 20A

#### Main fuse specification

Model	Specification	Parts No.	Code on LABEL, WIRING
SRC20/25/35	250V 15A	SSA564A136	F7
SRC40/50/60	250V 20A	SSA564A136A	F4

### 1.Preparing cable

#### (1) Selecting cable

Select the power source cable and connecting cable in accordance with the specifications mentioned below.

##### (a) Power source cable

- 3 cores\* 2.5mm<sup>2</sup> or more, conformed with 60245 IEC57
- When selecting the power source cable length, make sure that voltage drop is less than 2%.
- If the wire length gets longer, increase the wire diameter.

##### (b) Connecting cable

- 4 cores\* 1.5mm<sup>2</sup>, conformed with 60245 IEC57
- \* 1 Earth wire is included (Yellow/Green).

#### (2) Arrange each wire length as shown below.

Make sure that each wire is stripped 10mm from the end.

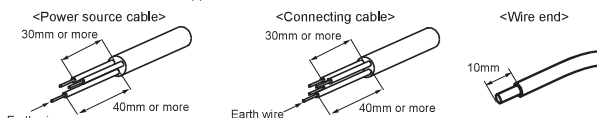

#### (3) Attach round crimp-type terminal to each wire as shown in the below.

Select the size of round crimp-type terminal after considering the specifications of terminal block and wire diameter.

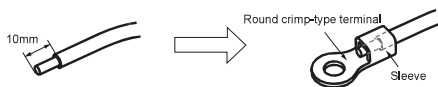

### ⚠ CAUTION

Power source cable and connecting cable must conform to the specifications mentioned in the manual. Using cables with wrong specifications may result in unit malfunction.

### 2.Connecting cable

#### (1) Remove the service cover.

#### (2) Connect the cables according to the instructions and figures given below.

##### (a) Connect the earth wire of power source cable.

An earth wire must be connected before connecting the other wires of power source cable. Keep the earth wire longer than the remaining two wires of power source cable.

##### (b) Connect the remaining two wires (N and L) of power source cable.

(c) Connect the wires of connecting cable. Make sure that for each wire, outdoor and indoor side terminal numbers match.

#### (3) Fasten the cables properly with cable clamps so that no external force may work on terminal connections.

Moreover, make sure that cables do not touch the piping, etc. When cables are connected, make sure that all electrical components within the electrical component box are free of loose connector coupling or terminal connection.

#### <Circuit diagram>

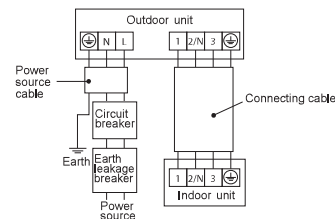

#### <SRC20/25/35>

#### <SRC40/50/60>

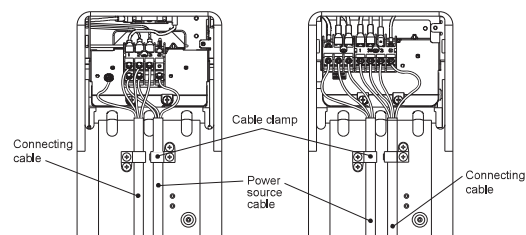

## 8. FINISHING WORK

### 1. Heating and condensation prevention

- Dress the connecting pipes (both liquid and gas pipes) with insulation to prevent it from heating and dew condensation. Use the heat insulating material which can withstand 120°C or higher temperature. Make sure that insulation is wrapped tightly around the pipes and no gap is left between them.
- Wrap the refrigerant pipings of indoor unit with indoor unit heat insulation using tape.
- Cover the flare-connected joints (indoor side) with the indoor unit heat insulation and wrap it with an insulation pad (standard accessory provided with indoor unit).
- Wrap the connecting pipes, connecting cable and drain hose with the tape.

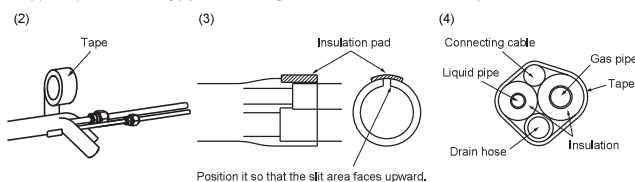

### NOTE

Locations where relative humidity exceeds 70%, both liquid and gas pipes need to be dressed with 20mm or thicker heat insulation materials.

### ⚠ CAUTION

- Improper insulation can cause condensate(water) formation during cooling operation. Condensate can leak or drip causing damage to household property.
- Poor heat insulating capacity can cause pipe outer surface to reach high temperature during heating operation. It can cause cable deterioration and personal injury.

### 2.Finishing work

- Make sure that the exterior portion of connecting pipes, connecting cable and drain hose is wrapped properly with tape. Shape the connecting pipes to match with the contours of the pipe assembly route.
- Fix the pipe assembly with the wall using clamps and screws. Pipe assembly should be anchored every 1.5m or less to isolate the vibration.
- Install the service cover securely. Water may enter the unit if service cover is not installed properly, resulting in unit malfunction and failure.

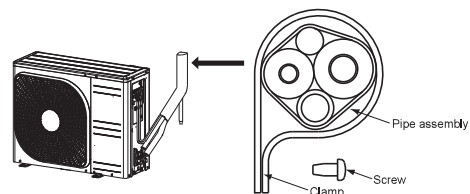

### ⚠ CAUTION

Make sure that the connecting pipes do not touch the components within the unit. If pipes touch the internal components, it may generate abnormal sounds and/or vibrations.

## 9. INSTALLATION TEST CHECK POINTS

After finishing the installation work, check the following points again before turning on the power. Conduct test run (Refer to indoor unit installation manual) and ensure that the unit operates properly.

Power source voltage complies with the rated voltage of air-conditioner.	
Earth leakage breaker and circuit breaker are installed.	
Power cable and connecting cable are securely fixed to the terminal block.	
Both liquid and gas service valves are fully open.	





No gas leaks from the joints of the service valves.	
Indoor and outdoor side pipe joints have been insulated.	
Drain hose (if installed) is fixed properly.	
Screw of the service cover is tightened properly.	



**(3) Safety precautions in handling air-conditioners with flammable refrigerants**

WALL TYPE AIR-CONDITIONER  
R32 REFRIGERANT USED

RSA012A061

	This equipment uses flammable refrigerants. If the refrigerant is leaked, together with an external ignition source, there is a possibility of ignition.		There is information included in the user's manual and/or installation manual.
	The user's manual should be read carefully.		A service personnel should be handing this equipment with reference to the installation manual.

The precautionary items mentioned below are distinguished into two levels, **WARNING** and **CAUTION**.

**WARNING** : Wrong installation would cause serious consequences such as injuries or death.

**CAUTION** : Wrong installation might cause serious consequences depending on circumstances.

**WARNING**

- Strict compliance of the domestic laws must be observed when disposing the appliance.
- Do not use means to accelerate the defrosting process or to clean, other than those recommended by the manufacturer.
- The appliance shall be stored in a room without continuously operating ignition sources (for example: open flames, an operating gas appliance or a operating electric heater).
- Do not pierce or burn.
- Be aware that refrigerants may not contain an odour.
- The indoor unit shall be stored in a room that has a minimum area of 8.6 m<sup>2</sup>.

**CAUTION**

**1. General**

- That the installation of pipe-work shall be kept to a minimum.
- That pipe-work shall be protected from physical damage.
- That compliance with national gas regulations shall be observed.
- That mechanical connections shall be accessible for maintenance purposes.
- Keep any required ventilation openings clear of obstruction.
- Servicing shall be performed only as recommended by the manufacturer.

**2. Unventilated areas**

- The appliance shall be stored in a well-ventilated area where the room size corresponds to the room area as specified for operation

**3. Qualification of worker**

- The staff in servicing operations must hold the national qualification or other relevant qualification

**4. Information on servicing**

- 4.1 Checks to the area**
- Prior to beginning work on systems containing flammable refrigerants, safety checks are necessary to ensure that the risk of ignition is minimised.
  - For repair to the refrigerating system, 4.3 to 4.7 shall be completed prior to conducting work on the system.
- 4.2 Work procedure**
- Work shall be undertaken under a controlled procedure so as to minimise the risk of a flammable gas or vapour being present while the work is being performed.
- 4.3 General work area**
- All maintenance staff and others working in the local area shall be instructed on the nature of work being carried out.
  - Work in confined spaces shall be avoided
  - The area around the workspace shall be sectioned off.
  - Ensure that the conditions within the area have been made safe by control of flammable material
- 4.4 Checking for presence of refrigerant**
- The area shall be checked with an appropriate refrigerant detector prior to and during work, to ensure the technician is aware of potentially toxic or flammable atmospheres
  - Ensure that the leak detection equipment being used is suitable for use with all applicable refrigerants, i.e. non-sparking, adequately sealed or intrinsically safe.

**4.5 Presence of fire extinguisher**

- If any hot work is to be conducted on the refrigeration equipment or any associated parts, appropriate fire extinguishing equipment shall be available to hand. Have a dry powder or CO<sub>2</sub> fire extinguisher adjacent to the charging area.

**4.6 No ignition sources**

- No person carrying out work in relation to a refrigeration system which involves exposing any pipe work shall use any sources of ignition in such a manner that it may lead to the risk of fire or explosion.
- All possible ignition sources, including cigarette smoking, should be kept sufficiently far away from the site of installation, repairing, removing and disposal, during which refrigerant can possibly be released to the surrounding space.
- Prior to work taking place, the area around the equipment is to be surveyed to make sure that there are no flammable hazards or ignition risks
- "No Smoking" signs shall be displayed.

**4.7 Ventilated area**

- Ensure that the area is in the open or that it is adequately ventilated before breaking into the system or conducting any hot work.
- A degree of ventilation shall continue during the period that the work is carried out.
- The ventilation should safely disperse any released refrigerant and preferably expel it externally into the atmosphere.

**4.8 Checks to the refrigeration equipment**

- Where electrical components are being changed, they shall be fit for the purpose and to the correct specification.
- At all times the manufacturer's maintenance and service guidelines shall be followed.
- If in doubt consult the manufacturer's technical department for assistance.
- The following checks shall be applied to installations using flammable refrigerants
  - the charge size is in accordance with the room size within which the refrigerant containing parts are installed;
  - the ventilation machinery and outlets are operating adequately and are not obstructed;
  - if an indirect refrigerating circuit is being used, the secondary circuit shall be checked for the presence of refrigerant;
  - marking to the equipment continues to be visible and legible. Markings and signs that are illegible shall be corrected;
  - refrigeration pipe or components are installed in a position where they are unlikely to be exposed to any substance which may corrode refrigerant containing components, unless the components are constructed of materials which are inherently resistant to being corroded or are suitably protected against being so corroded.

**4.9 Checks to electrical devices**

- Repair and maintenance to electrical components shall include initial safety checks and component inspection procedures.
- If a fault exists that could compromise safety, then no electrical supply shall be connected to the circuit until it is satisfactorily dealt with.
- If the fault cannot be corrected immediately but it is necessary to continue operation, an adequate temporary solution shall be used.
- This shall be reported to the owner of the equipment so all parties are advised.
- Initial safety checks shall include:
  - that capacitors are discharged: this shall be done in a safe manner to avoid possibility of sparking;
  - that no live electrical components and wiring are exposed while charging, recovering or purging the system;
  - that there is continuity of earth bonding.

**5. Repairs to sealed components**

- During repairs to sealed components, all electrical supplies shall be disconnected from the equipment being worked upon prior to any removal of sealed covers, etc.
- If it is absolutely necessary to have an electrical supply to equipment during servicing, then a permanently operating form of leak detection shall be located at the most critical point to warn of a potentially hazardous situation.
- Particular attention shall be paid to the following to ensure that by working on electrical components, the casing is not altered in such a way that the level of protection is affected. This shall include damage to cables, excessive number of connections, terminals not made to original specification, damage to seals, incorrect fitting of glands, etc
- Ensure that the apparatus is mounted securely.
- Ensure that seals or sealing materials have not degraded to the point that they no longer serve the purpose of preventing the ingress of flammable atmospheres.
- Replacement parts shall be in accordance with the manufacturer's specifications

**NOTE**

The use of silicon sealant can inhibit the effectiveness of some types of leak detection equipment. Intrinsically safe components do not have to be isolated prior to working on them.

**⚠ CAUTION**

**6. Repair to intrinsically safe components**

- Do not apply any permanent inductive or capacitance loads to the circuit without ensuring that this will not exceed the permissible voltage and current permitted for the equipment in use.
- Intrinsically safe components are the only types that can be worked on while live in the presence of a flammable atmosphere
- The test apparatus shall be at the correct rating.
- Replace components only with parts specified by the manufacturer.
- Other parts may result in the ignition of refrigerant in the atmosphere from a leak.

**7. Cabling**

- Check that cabling will not be subject to wear, corrosion, excessive pressure, vibration, sharp edges or any other adverse environmental effects. The check shall also take into account the effects of aging or continual vibration from sources such as compressors or fans.

**8. Detection of flammable refrigerant**

- Under no circumstances shall potential sources of ignition be used in the searching for or detection of refrigerant leaks.
- A halide torch (or any other detector using a naked flame) shall not be used

**9. Leak detection methods**

- Electronic leak detectors may be used to detect refrigerant leaks but, in the case of flammable refrigerants, the sensitivity may not be adequate, or may need re-calibration. (Detection equipment shall be calibrated in a refrigerant-free area.)
- Ensure that the detector is not a potential source of ignition and is suitable for the refrigerant used.
- Leak detection equipment shall be set at a percentage of the LFL of the refrigerant and shall be calibrated to the refrigerant employed, and the appropriate percentage of gas (25 % maximum) is confirmed
- Leak detection fluids are suitable for use with most refrigerants but the use of detergents containing chlorine shall be avoided as the chlorine may react with the refrigerant and corrode the copper pipe-work.
- If a leak is suspected, all naked flames shall be removed/extinguished.
- If a leakage of refrigerant is found which requires brazing, all of the refrigerant shall be recovered from the system, or isolated (by means of shut off valves) in a part of the system remote from the leak.
- For appliances containing flammable refrigerants, oxygen free nitrogen (OFN) shall then be purged through the system both before and during the brazing process.

**10. Removal and evacuation**

- When breaking into the refrigerant circuit to make repairs – or for any other purpose – conventional procedures shall be used. However, for flammable refrigerants it is important that best practice is followed since flammability is a consideration
- The following procedure shall be adhered to:
  - remove refrigerant;
  - purge the circuit with inert gas;
  - evacuate;
  - purge again with inert gas;
  - open the circuit by cutting or brazing.
- The refrigerant charge shall be recovered into the correct recovery cylinders.
- For appliances containing flammable refrigerants, the system shall be “flushed” with OFN to render the unit safe. This process may need to be repeated several times.
- Compressed air or oxygen shall not be used for purging refrigerant systems.

- For appliances containing flammable refrigerants, flushing shall be achieved by breaking the vacuum in the system with OFN and continuing to fill until the working pressure is achieved, then venting to atmosphere, and finally pulling down to a vacuum. This process shall be repeated until no refrigerant is within the system.
- When the final OFN charge is used, the system shall be vented down to atmospheric pressure to enable work to take place. This operation is absolutely vital if brazing operations on the pipe-work are to take place.
- Ensure that the outlet for the vacuum pump is not close to any ignition sources and that ventilation is available.

**11. Charging procedures**

- In addition to conventional charging procedures, the following requirements shall be followed.
  - Ensure that contamination of different refrigerants does not occur when using charging equipment. Hoses or lines shall be as short as possible to minimise the amount of refrigerant contained in them.
  - Cylinders shall be kept upright.
  - Ensure that the refrigeration system is earthed prior to charging the system with refrigerant.
  - Label the system when charging is complete (if not already).
  - Extreme care shall be taken not to overfill the refrigeration system.
- Prior to recharging the system, it shall be pressure-tested with the appropriate purging gas.
- The system shall be leak-tested on completion of charging but prior to commissioning.
- A follow up leak test shall be carried out prior to leaving the site.

**12. Decommissioning**

- Before carrying out this procedure, it is essential that the technician is completely familiar with the equipment and all its detail.
- It is recommended good practice that all refrigerants are recovered safely.
- Prior to the task being carried out, an oil and refrigerant sample shall be taken in case analysis is required prior to re-use of reclaimed refrigerant.
- It is essential that electrical power is available before the task is commenced.
  - a) Become familiar with the equipment and its operation.
  - b) Isolate system electrically.
  - c) Before attempting the procedure ensure that:
    - mechanical handling equipment is available, if required, for handling refrigerant cylinders;
    - all personal protective equipment is available and being used correctly;
    - the recovery process is supervised at all times by a competent person;
    - recovery equipment and cylinders conform to the appropriate standards.
  - d) Pump down refrigerant system, if possible.
  - e) If a vacuum is not possible, make a manifold so that refrigerant can be removed from various parts of the system.
  - f) Make sure that cylinder is situated on the scales before recovery takes place.
  - g) Start the recovery machine and operate in accordance with manufacturer’s instructions.
  - h) Do not overfill cylinders. (No more than 80 % volume liquid charge).
    - i) Do not exceed the maximum working pressure of the cylinder, even temporarily.
  - j) When the cylinders have been filled correctly and the process completed, make sure that the cylinders and the equipment are removed from site promptly and all isolation valves on the equipment are closed off.
  - k) Recovered refrigerant shall not be charged into another refrigeration system unless it has been cleaned and checked.

**13. Labelling**

- Equipment shall be labelled stating that it has been de-commissioned and emptied of refrigerant. The label shall be dated and signed.
- For appliances containing flammable refrigerants, ensure that there are labels on the equipment stating the equipment contains flammable refrigerant.

**14. Recovery**

- When removing refrigerant from a system, either for servicing or decommissioning, it is recommended good practice that all refrigerants are removed safely.
- When transferring refrigerant into cylinders, ensure that only appropriate refrigerant recovery cylinders are employed.
- Ensure that the correct number of cylinders for holding the total system charge are available.
- All cylinders to be used are designated for the recovered refrigerant and labelled for that refrigerant (i.e. special cylinders for the recovery of refrigerant).
- Cylinders shall be complete with pressure relief valve and associated shut-off valves in good working order.
- Empty recovery cylinders are evacuated and, if possible, cooled before recovery occurs.
- The recovery equipment shall be in good working order with a set of instructions concerning the equipment that is at hand and shall be suitable for the recovery of all appropriate refrigerants including, when applicable, flammable refrigerants
- In addition, a set of calibrated weighing scales shall be available and in good working order.
- Hoses shall be complete with leak-free disconnect couplings and in good condition.
- Before using the recovery machine, check that it is in satisfactory working order, has been properly maintained and that any associated electrical components are sealed to prevent ignition in the event of a refrigerant release. Consult manufacturer if in doubt.
- The recovered refrigerant shall be returned to the refrigerant supplier in the correct recovery cylinder, and the relevant Waste Transfer Note arranged. Do not mix refrigerants in recovery units and especially not in cylinders.
- If compressors or compressor oils are to be removed, ensure that they have been evacuated to an acceptable level to make certain that flammable refrigerant does not remain within the lubricant.
- The evacuation process shall be carried out prior to returning the compressor to the suppliers.
- Only electric heating to the compressor body shall be employed to accelerate this process.
- When oil is drained from a system, it shall be carried out safely.

**15. Other safety precautions**

- A brazed, welded, or mechanical connection shall be made before opening the valves to permit refrigerant to flow between the refrigerating system parts.
- Flammable refrigerant used, refrigerant tubing protected or enclosed to avoid mechanical damage (IEC/EN 60335-2-40/A1).
- Tubing protected to extent that it will not be handled or used for carrying during moving of product (IEC/EN 60335-2-40/A1).
- Flammable refrigerant used, low temperature solder alloys, such as lead/tin alloys, not acceptable for pipe connections (IEC/EN 60335-2-40/A1).
- When there is flare connection, it must be installed outdoor.

- **Transport of equipment containing flammable refrigerants**

Transportation regulations of each country must be complied.

- **Marking of equipment using signs**

Employers should ensure that employees receive suitable and sufficient instruction and training on the meaning of appropriate safety signs and the actions that need to be taken in connection with these signs.

- **Competence of service personnel**

Service personnel who handle this air-conditioner are required to complete a special training course, in addition to ordinary repairing procedures. The training must include following items.

1. Information about the explosion potential of flammable refrigerants to show that flammables may be dangerous when handled with care.

2. Information about potential ignition sources, especially those that are not obvious, such as lighters, light switches, vacuum cleaners, electric heaters.

3. Information concerning the concept of safety

Although safety of this equipment does not rely on the ventilation of enclosure, in the event that the enclosure is opened up to atmosphere while remaining refrigerant is accumulated in it, flammable atmosphere could be released to the outside.

4. Information about the concept of sealed components and sealed enclosures according to IEC 60079-15:2010.

5. Information about the correct working procedures:

① **Commissioning**

- Ensure that the floor area is sufficient for the refrigerant charge or that the ventilation duct is assembled in a correct manner.
- Connect the pipes and carry out a leak test before charging with refrigerant.
- Check safety equipment before putting into service.

② **Maintenance**

- Portable equipment shall be repaired outside or in a workshop specially equipped for servicing units with flammable refrigerants.
- Ensure sufficient ventilation at the repair place
- Be aware that malfunction of the equipment may be caused by refrigerant loss and a refrigerant leak is possible.
- Discharge capacitors in a way that won't cause any spark. The standard procedure to short circuit the capacitor terminals usually creates sparks.
- Reassemble sealed enclosures accurately. If seals are worn, replace them.
- Check safety equipment before putting into service.

③ **Repair**

- Portable equipment shall be repaired outside or in a workshop specially equipped for servicing units with flammable refrigerants.
- Ensure sufficient ventilation at the repair place
- Be aware that malfunction of the equipment may be caused by refrigerant loss and a refrigerant leak is possible.
- Discharge capacitors in a way that won't cause any spark.
- In the event that a brazing work is required, the refrigerant must be collected in a proper collecting container.
- Purge the braze point with nitrogen during the brazing procedure.
- Carry out a leak test before charging with refrigerant.
- Reassemble sealed enclosures accurately. If seals are worn, replace them.

④ **Decommissioning**

- If the safety is affected when the equipment is put out of service, the refrigerant charge shall be removed before decommissioning.
- Ensure sufficient ventilation at the equipment location
- Be aware that malfunction of the equipment may be caused by refrigerant loss and a refrigerant leak is possible.
- Discharge capacitors in a way that won't cause any spark.
- Collect refrigerant always in a proper collecting container.
- After collecting refrigerant, charge nitrogen gas till the inside of refrigerating cycle is filled up to the atmospheric pressure.
- Put a label on the equipment that the refrigerant is removed.

⑤ **Disposal**

- Ensure sufficient ventilation at the working place
- Collect refrigerant always in a proper collecting container.
- Waste material must be collected and disposed according to the national or local guidelines.