



**SAMSUNG**

# MULTI AIR CONDITIONER

## INDOOR UNIT

AJ009JNNDCH/AA  
AJ012JNNDCH/AA  
AJ018JNNDCH/AA  
AJ007JNADCH/AA  
AJ009JNADCH/AA  
AJ012JNADCH/AA  
AJ018JNADCH/AA  
AJ024JNADCH/AA  
AJ009JNLDCH/AA  
AJ012JNLDCH/AA  
AJ018JNLDCH/AA  
AJ009NBNDCH/AA  
AJ012NBNDCH/AA  
AJ018NBNDCH/AA

## OUTDOOR UNIT

AJ020JCJ2CH/AA  
AJ024JCJ3CH/AA  
AJ036JCJ5CH/AA

# ***SERVICE*** Manual

## AIR CONDITIONER



## CONTENTS

1. Precautions
2. Product Specifications
3. Disassembly and Reassembly
4. Troubleshooting
5. PCB Diagram and Parts List
6. Wiring Diagram
7. Reference Sheet

# Contents

<b>1. Precautions</b> .....	<b>1-1</b>
1-1 Installing the air conditioner .....	1-1
1-2 Power supply and circuit breaker .....	1-1
1-3 During operation .....	1-2
1-4 Disposing of the unit .....	1-2
1-5 Others .....	1-2
<b>2. Product Specifications</b> .....	<b>2-1</b>
2-1 The Feature of Product .....	2-1
2-2 Product Specifications .....	2-2
2-3 Accessory and Specifications .....	2-8
<b>3. Disassembly and Reassembly</b> .....	<b>3-1</b>
3-1 Indoor Unit .....	3-2
3-2 Outdoor Unit .....	3-29
<b>4. Trouble shooting</b> .....	<b>4-1</b>
4-1 Display Error and Check Method .....	4-1
4-1-1 Indoor Unit .....	4-1
4-1-2 Outdoor Unit .....	4-5
4-2 Setting Option Setup Method .....	4-7
4-2-1 Setting an indoor unit address and installation option .....	4-7
4-2-2 Changing a particular option .....	4-11
4-3 Items to be checked first .....	4-12
4-4 Checking and Testing operation .....	4-16
4-5 Fault Diagnosis by Symptom .....	4-24
4-5-1 Indoor .....	4-24
4-5-1-1 Indoor temperature sensor (open/short) .....	4-24
4-5-1-2 Indoor FAN Error ( BLDC MOTOR MODEL ) .....	4-25
4-5-1-3 Communication error after finishing Tracking .....	4-26
4-5-1-4 EEPROM circuit failure .....	4-27
4-5-2 Outdoor unit is not powered on – Initial diagnosis(1phase) .....	4-28
4-5-3 Outdoor unit fan error .....	4-29
4-5-4 Compressor startup error, Compressor Lock error, Compressor rotation error. ....	4-30
4-5-5 IPM Over Current error .....	4-31
4-5-6 Checking Temperature sensor .....	4-32
4-5-6-1 Outdoor Discharge/OLP temperature sensor error .....	4-32
4-5-6-2 Outdoor out/cond temperature sensor error .....	4-33
4-5-7 Checking EEV .....	4-33
4-6 PCB Inspection Method .....	4-34
<b>5. PCB Diagram and Parts list</b> .....	<b>5-1</b>
5-1 Indoor Unit .....	5-1
5-2 Outdoor Unit .....	5-5
<b>6. Wiring Diagram</b> .....	<b>6-1</b>
6-1 Indoor Unit .....	6-1
6-2 Outdoor Unit .....	6-4
<b>7. Reference Sheet</b> .....	<b>7-1</b>

---

# 1. Precautions

---

## 1-1 Installing the air conditioner

---

- Users should not install the air conditioner by themselves.  
Ask the dealer or authorized company to install the air conditioner except the window-type air conditioner in U.S.A and Canada.
- If you don't install the air conditioner properly, it may cause a fire, a water leakage or an electric shock.
- You must install the air conditioner according to the national wiring regulations and safety regulations.
- Install the indoor unit higher than 2.5m from the floor to avoid the injury caused by the operation of the fan. (except the window-type air conditioner)
- The manufacturer is not responsible for any accidents or injury caused by an incorrect installation.

When installing the built-in type air conditioner, keep all electric cables such as the power cable and the connection cord in pipes, ducts, or cable channels to protect them from the danger of impact or any other incidents.

- More than 2 indoor units should be installed when you use Free Joint Multi air conditioner.
- AJ020JCJ2CH  
- \*\*018/024\*\* indoor units cannot be connected.  
AJ024JCJ3CH  
- \*\*024\*\*\* indoor units cannot be connected.

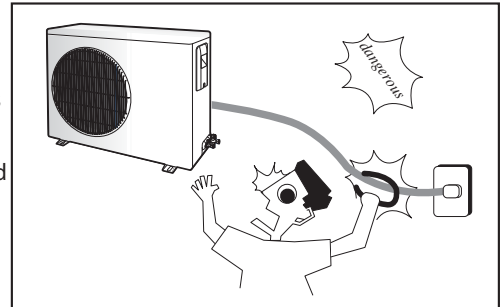

**Avoid Dangerous Contact**

## 1-2 Power supply and circuit breaker

---

- If the power cord of the air conditioner is damaged, it must be replaced by the manufacturer or a qualified person in order to avoid a hazard.
- The air conditioner must be plugged into an independent circuit if applicable or connect the power cable to the auxiliary circuit breaker.  
An all pole disconnection from the power supply must be incorporated in the fixed wiring with a contact opening of >3mm.
- Do not extend an electric cord to the air conditioner.
- The air conditioner must be plugged in after you complete the installation.

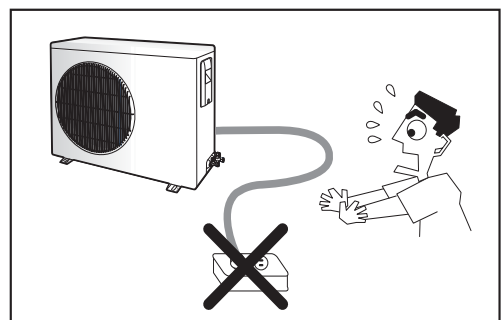

**No Tapping and No Extension Cords**

## 1-3 During operation

---

- Do not repair the air conditioner at your discretion.  
It is recommended to contact a service center directly.
- Never spill any kind of liquid on the air conditioner.  
If this happens, turn off the air conditioner and contact an authorized service center.
- Do not insert anything between the airflow blades to prevent damage of the inner fan and consequent injury. Keep children away from the air conditioner.
- Do not place any obstacles in front of the air conditioner.
- Do not spray any kind of liquid into the indoor unit. If this happens, turn off the air conditioner and contact a service center.
- Make sure that the air conditioner is well ventilated at all times:  
Do not place a cloth or other materials over it.
- Remove the batteries if you don't use the remote control for a long time. (If applicable)
- Use the remote control within 7 meters from the indoor unit. (If applicable)

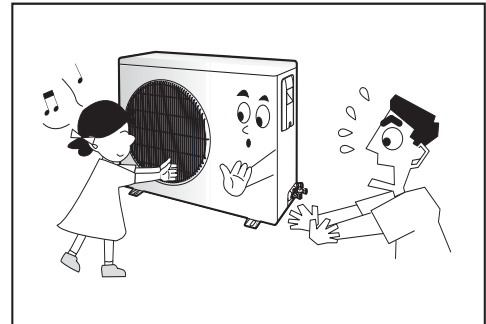

**No children Nearby**

## 1-4 Disposing of the unit

---

- Before throwing out the air conditioner, remove the batteries from the remote control.
- When you dispose of the air conditioner, consult your dealer. If pipes are removed incorrectly, refrigerant may blow out and cause air pollution. When it contacts with your skin, it can cause skin injury.
- The package of the air conditioner should be recycled or disposed of properly for environmental reasons.

## 1-5 Others

---

- Never store or load the air conditioner upside down or sideways to prevent the damage to the compressor.
- Young children or infirm persons should be always supervised when they use the air conditioner.
- Max current is measured according to IEC standard for safety.
- Current is measured according to ISO standard for energy efficiency.
- When installing, make sure there is no leakage. When recovering the refrigerant, ground the compressor first before removing the connection pipe. If the refrigerant pipe is not properly connected and the compressor works with the service valve open, the pipe inhales the air and it makes the pressure inside of the refrigerant cycle abnormally high. It may cause explosion and injury.
- Pump Down Procedure (When removing the product)
  - Turn on the air conditioner and select Cool mode to run the compressor for 3 minutes.
  - Release the valve caps on High and Low pressure side.
  - Use L wrench to close the valve on the high pressure side.
  - Approximately 2 minutes after, close the valve on the low pressure side.
  - Stop operation of the air conditioner.- Disconnect the pipes.

---

## 2. Product Specifications

---

### 2-1 The Feature of Product

---

■ **Multi Inverter(Free Joint Multi) Series delivers comfort to 2~5 rooms with a Single Outdoor Unit.**

■ **Inverter for High Efficiency Operation.**

Thanks to inverter control, efficiency of operation of the outdoor unit is enhanced depending on the number of indoor units operated and the temperature setting.

When only one indoor unit is used, power is saved, resulting in a smaller electricity bill. When all indoor units are used, high-power operation achieves comfort quickly in all rooms.

■ **Installation of indoor units on different floors is possible.**

■ **Characteristics**

•Using electronic expansion valve control

■ **Various Indoor units & combinations**

- Mini 4 way cassette
- Slim duct
- A3050

■ **Convenient Installation**

Auto addressing option : Automated checking of pipe connection.(Refer to the installation manual for detail)

■ **Space saving & Environmental Friendly**

- Compact & light outdoor unit
- Slim and quiet indoor units
- Pipe size reduction
- Ozone friendly Refrigerant(R410A)
- Lead Free controller.

■ **Reliability**

- Installation possibilities(Length/Height)
- Convenient installation(485 non polarity/auto-addressing)
- Intelligent control/network
- Easy checking system condition by 7-segment

■ **Smart & Low Noise outdoor units in any condition**

- TBR/Sine-Wave Controller/Noise Reduction Control/Dual Felt etc.
- Felt Structure : New felt has selected to reduce the noise coming out of the compressor.

Double layered felt structure absorbs noise by two times and felt is also covering top of the compressor to reduce the noise even more.

## 2-2 Product Specifications

ITEM				AJ009JNNDCH	AJ012JNNDCH	AJ018JNNDCH
				INDOOR UNIT		
Type				Mini 4 way cassette		
Performance	Cooling		Btu/h	8900	11900	17700
	Heating			9900	13000	19100
	Air Volume	Cooling	m <sup>3</sup> /min	9	9.6	10.5
		Heating		10.6	11.3	13.5
	Noise	Cooling	dB(A)	38	41	44
		Heating		39	42	45
Power			Φ,V,Hz			1, 208~230, 60
Power	Power Consumption	Cooling	W	19	22	28
		Heating		19	22	28
	Operating Current	Cooling	A	0.51	0.52	0.53
		Heating		0.51	0.52	0.53
EER	Cooling/Heating		Btu/Wh	- / -	- / -	- / -
Size	Outer Dimension	W*H*D	mm	575*250*575		
	Weight		kg	11.4		11.8
	Refrigerant Pipe	Gas	Inch	'3/8		
		Liquid	Inch	'1/4		
Fan Motor & Blower	Blower	Type		-		
		Size	mm	Φ320*1ea, 7B		
	Motor	Type		BLDC		
		Capacitor	uF×VAC	-		
Heat Exchanger				Φ7*2R*8S*1357 (1387.3+1327.5)		Φ7*2R*10S*1357 (1387.3+1327.5)
Option Code				01507F-1660F8-231A21-300100	01507F-166219-232328-300100	01507F-17625D-23343C-300100

ITEM				AJ009JNLDCH	AJ012JNLDCH	AJ018JNLDCH
				INDOOR UNIT		
Type				Slim Duct		
Performance	Cooling		Btu/h	9000	12000	18000
	Heating			10000	13000	19000
	Air Volume	Cooling	m <sup>3</sup> /min	8.3	9.8	14.8
		Heating		8.3	9.8	14.8
	Noise	Cooling	dB(A)	37		
		Heating		38		37
Power			Φ,V,Hz			1, 208~230, 60
Power	Power Consumption	Cooling	W	76		150
		Heating		76		150
	Operating Current	Cooling	A	0.35		0.69
		Heating		0.35		0.69
EER	Cooling/Heating		Btu/Wh	- / -	- / -	- / -
Size	Outer Dimension	W*H*D	mm	900*199*600		1100*199*600
	Weight		kg	23.3		29.0
	Refrigerant Pipe	Gas	mm	9.52		12.7
		Liquid	mm	6.35		
Fan Motor & Blower	Blower	Type		-		
		Size	mm	Φ92XL634		Φ92XL844.3
	Motor	Type		-		
		Capacitor	uF×VAC	-		
Heat Exchanger				Φ7,FP1.5,SLIT,NGS		Φ7,FP1.3,SLIT,NGS
Option Code				015201-14023E-200001-300000	015201-160370-200001-300000	011224-1940E6-200001-300000

## Product Specifications(cont.)

ITEM				AJ018JNADCH	AJ024JNADCH	
				INDOOR UNIT		
Type				Wall-mounted		
Performance	Cooling		Btu/h	17100	22000	
	Heating			20000	25500	
	Air Volume	Cooling	m <sup>3</sup> /min	-	-	
		Heating		-	-	
	Noise	Cooling	dB(A)	50	51	
		Heating		46	50	
Power			Φ,V,Hz		1, 208~230, 60	
Power	Power Consumption	Cooling	W	50	50	
		Heating		50	50	
	Operating Current	Cooling	A	0.4	0.4	
		Heating		0.4	0.4	
EER	Cooling/Heating		Btu/Wh	- / -	- / -	
Size	Outer Dimension	W*H*D	mm	1063*317*294		
	Weight			kg	13	14
	Refrigerant Pipe	Liquid	mm	6.35 (1/4 inch)		
		Gas	mm	12.70 (1/2 inch)	15.88 (5/8 inch)	
Fan Motor & Blower	Blower	Type		Cross Flow Fan		
		Size	mm	Φ106xL830		
	Motor	Type		BLDC		
		Capacitor	uF	VAC		
Heat Exchanger				Φ7, F.P1.3, H-fin(hydrophile)	Φ7, F.P1.3, H-fin, NGS	
Option Code				010025-15622A-27323C-372604	010025-15625C-274450-372604	

ITEM				AJ007JNADCH	AJ009JNADCH	AJ012JNADCH
				INDOOR UNIT		
Type				Wall-mounted		
Performance	Cooling		Btu/h	7000	9000	12000
	Heating			7500	10900	14000
	Air Volume	Cooling	m <sup>3</sup> /min	-	-	-
		Heating		-	-	-
	Noise	Cooling	dB(A)	45		47
		Heating		43		45
Power			Φ,V,Hz			1, 208~230, 60
Power	Power Consumption	Cooling	W	30	30	30
		Heating		30	30	30
	Operating Current	Cooling	A	0.3	0.3	0.3
		Heating		0.3	0.3	0.3
EER	Cooling/Heating		Btu/Wh	- / -	- / -	- / -
Size	Outer Dimension	W*H*D	mm	826*275*260		
	Weight			kg	9.5	
	Refrigerant Pipe	Liquid	mm	6.35 (1/4 inch)		
		Gas	mm	9.52 (3/8 inch)		
Fan Motor & Blower	Blower	Type		Cross Flow Fan		
		Size	mm	Φ98xL633		
	Motor	Type		BLDC		
		Capacitor	uF	VAC		
Heat Exchanger				Φ7, F.P1.3, H-fin, Hydrophille		Φ7, F.P1.3, H-fin, hydro
Option Code				010025-16623A-271416-372A04	010025-16624A-271920-372A04	010025-16626B-272328-372B04

## Product Specifications(cont.)

Model				AJ009NBNDCH/AA	AJ012NBNDCH/AA	AJ018NBNDCH/AA
				INDOOR UNIT		
Item				Wind-Free Mini 4 way cassette		
Type				Wind-Free Mini 4 way cassette		
Performance	Capacity	Cooling	kW	2.6	3.5	5.2
		Heating		2.9	3.8	5.6
	Air Volume		m <sup>3</sup> /min	-	-	-
	Noise	Cooling	dB(A)	39	42	45
Heating		39		42	45	
Power	Power		φ, V, Hz	1,208-230,60	1,208-230,60	1,208-230,60
	PowerConsumption	Cooling	W	19	22	28
		Heating		19	22	28
	Operating Current	Cooling	A	0.51	0.52	0.53
Heating		0.51		0.52	0.53	
Size	Outer Dimension	Net Size	W*H*D(mm)	575 x 250 x 575	575 x 250 x 575	575 x 250 x 575
	Weight(net)	Net Weight	Kg	11.5	11.5	11.7
	Refrigerant Pipe	Liquid	mm	6.35	6.35	6.35
		Gas	mm	9.52	9.52	12.70
	Blower	Type			Turbo Fan	Turbo Fan
Motor		Rated Output (W)		-	-	-
Heat Exchanger				2ROWx8STEP	2ROWx8STEP	2ROWx10STEP
Refrigerant Control Device				EEV	EEV	EEV



## Product Specifications(cont.)

ITEM				AJ020JCJ2CH	AJ024JCJ3CH	AJ036JCJ5CH
				OUTDOOR UNIT		
Type				Free Joint Multi		
Performance	Capacity	Cooling	Btu/h	17000	22000	36000
		Heating		22000	25000	4000
	Air Volume		m <sup>3</sup> /min	47.5	46.89	70.58
	Noise	Cooling	dB(A)	54	55	59
		Heating		57	57	63
Power			Φ,V,Hz	1, 208~230, 60		
Power	Power Consumption	Cooling	W	1390	1820	3450
		Heating		1730	1780	3150
	Operating Current	Cooling	A	6.7	8.7	16.5
		Heating		8.3	8.5	15.1
Fuse Capacity			A	30	-	
EER/COP	Cooling/Heating		EER : Btu/Wh COP : W/W	12.2 / 3.73	12.1 / 4.12	10 / 3.72
Size	Dimension	W*H*D	mm	880*798*310		940*998*330
	Net Weight		kg	57.3	65.0	75.5
Compressor	Type			Twin BLDC Rotary		
	Model name			UG4T200FUAE4	G8T260FUAEW	UG8T300FUBJU
	Motor	Type		BLDC		
	Lubricant Oil	Type		POE		
		Capacity	cc	650	700	1200
Protection Device			-	-	-	
Fan Motor & Blower	Blower	Type		Propeller		
		Size	mm	ø460		ø520
	Motor	Type		-	-	-
Capacitor		uFxVAC	-	-	-	
Heat Exchanger				-	-	-
Refrigerant Control Unit				-	-	-
Charging Refrigerant(R410A)			g	2200 (charged for 30m)	2800 (charged for 40m)	3300 (charged for 40m)
Additional Refrigerant (R410A)			g/m	10	10	20
Total Piping length			m	50	70	80
Max. Length (ODU to IDU)			m	25	25	25
Max. Height (OUD, more height)			m	15	15	15

Model	Total connecting pipe length (L)	Adding refrigerant
AJ020JCJ2CH	LT≤30m	Chargeless
	LT>30m	(LT- 30m)x10g
AJ024JCJ3CH	LT≤40m	Chargeless
	LT>40m	(LT- 40m)x10g
AJ036JCJ5CH	LT≤40m	Chargeless
	LT>40m	(LT- 40m)x20g



## Product Specifications(cont.)

ITEM		Model	
		AJ020JCJ2CH	
Design	Indoor Unit		
	Outdoor Unit		
Net Weight	Indoor Unit	AJ007/009/012JNADCH	9.5 kg
		AJ009/012JNNDCH	11.4 kg
		AJ009/012JNLDCH	23.3 kg
		AJ009/012NBNDCH	11.5 kg
	Outdoor Unit	AJ020JCJ2CH	57.3 kg
Dimemision	Indoor Unit	AJ007/009/012JNADCH	826*275*260 mm
		AJ009/012JNNDCH	575*250*575 mm
		AJ009/012JNLDCH	900*199*600 mm
		AJ009/012NBNDCH	575*250*575 mm
	Outdoor Unit	AJ020JCJ2CH	880*798*310 mm
Noise	Indoor Unit	AJ007/009JNADCH	45 dB↓
		AJ012JNADCH	47 dB↓
		AJ009JNNDCH	38 dB↓
		AJ012JNNDCH	41 dB↓
		AJ009/012JNLDCH	37 dB↓
		AJ009/012NBNDCH	39/42 dB↓
	Outdoor Unit	AJ020JCJ2CH	54 dB↓
The Feature of Product		Free Joint Multi(Variable Indoor Unit)	
Refrigerant Control Unit		BLDC INVERTER COMPRESSOR UG4T200FUAЕ4 	

## Product Specifications(cont.)







ITEM		Model	
		AJ024JCJ3CH	
Design	Indoor Unit		
	Outdoor Unit		
Net Weight	Indoor Unit	AJ007/009/012JNADCH	9.5 kg
		AJ018JNADCH	13.0 kg
		AJ009/012JNNDCH	11.4 kg
		AJ018JNNDCH	11.8 kg
		AJ009/012JNLDCH	23.3 kg
		AJ018JNLDCH	29.0 kg
	Outdoor Unit	AJ009/012/018NBNDCH	11.5/11.5/11.7 kg
		AJ024JCJ3CH	65.0 kg
Dimensio n	Indoor Unit	AJ007/009/012JNADCH	826*275*260 mm
		AJ018JNADCH	1063*317*294 mm
		AJ009/012/018JNNDCH	575*250*575 mm
		AJ009/012JNLDCH	900*199*600 mm
		AJ018JNLDCH	1100*199*600 mm
		AJ009/012/018NBNDCH	575*250*575 mm
	Outdoor Unit	AJ024JCJ3CH	880*798*310 mm
Noise	Indoor Unit	AJ007/009JNADCH	45 dB↓
		AJ012JNADCH	47 dB↓
		AJ018JNADCH	50 dB↓
		AJ009JNNDCH	38 dB↓
		AJ012JNNDCH	41 dB↓
		AJ018JNNDCH	44 dB↓
		AJ009/012/018JNLDCH	37 dB↓
		AJ009/012/018NBNDCH	39 /42 /45 dB↓
	Outdoor Unit	AJ024JCJ3CH	54 dB↓
The Feature of Product		Free Joint Multi(Variable Indoor Unit)	
Refrigerant Control Unit		BLDC INVERTER COMPRESSOR G8T260FUAEW 	

## Product Specifications(cont.)

ITEM		Model	
		AJ036JCJ5CH	
Design	Indoor Unit		
	Outdoor Unit		
Net Weight	Indoor Unit	AJ007/009/012JNADCH	9.5 kg
		AJ018JNADCH	13.0 kg
		AJ024JNADCH	14.0 kg
		AJ009/012JNNDCH	11.4 kg
		AJ018JNNDCH	11.8 kg
		AJ009/012JNLDCH	23.3 kg
		AJ018JNLDCH	29.0 kg
	Outdoor Unit	AJ009/012/018NBNDCH AJ036JCJ5CH	11.5/11.5/11.7 kg 75.5 kg
Dimemсион	Indoor Unit	AJ007/009/012JNADCH	826*275*260 mm
		AJ018/024JNADCH	1063*317*294 mm
		AJ009/012/018JNNDCH	575*250*575 mm
		AJ009/012JNLDCH	900*199*600 mm
		AJ018JNLDCH	1100*199*600 mm
	Outdoor Unit	AJ009/012/018NBNDCH AJ036JCJ5CH	575*250*575 mm 940*998*330 mm
Noise	Indoor Unit	AJ007/009JNADCH	45 dB↓
		AJ012JNADCH	47 dB↓
		AJ018JNADCH	50 dB↓
		AJ024JNADCH	51 dB↓
		AJ009JNNDCH	38 dB↓
		AJ012JNNDCH	41 dB↓
		AJ018JNNDCH	44 dB↓
		AJ009/012/018JNLDCH	37 dB↓
	Outdoor Unit	AJ009/012/018NBNDCH AJ036JCJ5CH	39/42/45 dB↓ 54 dB↓
The Feature of Product		Free Joint Multi(Variable Indoor Unit)	
Refrigerant Control Unit		BLDC INVERTER COMPRESSOR UG8T300FUBJU 	

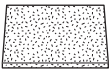
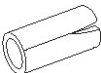
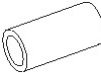
## 2-3 Accessory and Specifications









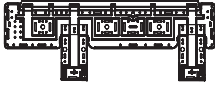

### ■ AJ009JNLDCH/AJ012JNLDCH/AJ018JNLDCH

Item	Descriptions	Code-No.	Q'TY	Remark
	Wired remote controller	DB97-15070D	1	Indoor Unit
	Owner's Manual	DB68-04994A	1	
	Installation Manual	DB68-04995A	1	
	Insulation cover	DB62-04318S	1	
	Insu drain hose	DB62-11028A	1	
	Insu hose C/D	DB62-11028E	1	
		DB62-11028D	1	
	Ass'y Holder Drain Pipe	DB90-06701A	1	
	Hose Drain	DB67-01191A	1	
	CARD WARRANTY	DB68-01675A	1	
	GARANTIE CARD	DB98-13261A	1	

\*The design and shape can be changed according to the model.

## Accessories(cont.)











### ■ AJ007JNADCH/AJ009JNADCH/AJ012JNADCH/AJ018JNADCH/AJ024JNADCH

Item	Descriptions	Code No	Qty	Rmark
	Installation Plate	DB90-07732A (03 frame)	1	Indoor Unit
	Installation Plate	DB90-07731A (05 frame)	1	
	Remote Control	DB93-14643R	1	
	Batteries for Remote Control	4301-000121	2	
	User's Manual	DB68-04992A	1	
	Installation Manual	DB68-04993A	1	
	Cap Screws	DB67-01404A	1	
	Case Sub PCB	DB61-06101A	1	
	CARD WARRANTY	DB68-01675A	1	
	GARANTIE CARD	DB98-13261A	1	

\* The design and shape can be changed according to the model.

**Accessories(cont.)**







AJ009/012/018JNNDCH, AJ009/012/018NBNDCH/AA

Item	Description	Code No.	Q'ty	Remark
	Ass'y drain hose	DB94-03287A	1	Essential Offer (Indoor Unit)
	Cable-tie	DB65-10088C	6	
	Seal-drain ass'y	DB62-11028A	1	
	Seal-drain ass'y	DB62-11028H	1	
	Seal-drain ass'y	DB62-11028J	1	
	USER MANUAL MANUAL USERS & INSTALL	DB68-04990A (AJ***JNNDCH) DB68-07759A (AJ***NBNDCH)	1	
	GARANTIE CARD	DB98-13261A	1	
	ASSY-INSTALLATION MANUAL	DB68-04991A (AJ***JNNDCH)	1	
	CARD WARRANTY	DB68-01675A	1	
	BOLT	6011-003975	4	Essential Offer (Panel)

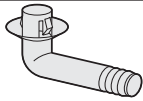
The design and shape can be changed according to the model.

## Accessories(cont.)

### ■ AJ020JCJ2CH/AJ024JCJ3CH

Item	Descriptions	Code No	Qty	Rmark
	Drain Plug Out	DB67-00477A	1	Outdoor Unit
	Energy Label	DB68-05062A(AJ020JCJ2CH) DB68-05062B(AJ024JCJ3CH)	2	
	Rubber Leg	DB73-20134A	4	
	Flare Nuts, 9.52mm outer pipe diameter	DB60-30010B (Only for AJ024JCJ3CH)	1	
	Installation Manual	DB68-04989A	1	
	Nipple Connector	DB67-00788A (Only for AJ024JCJ3CH)	1	

\* The design and shape can be changed according to the model.

\* The design and shape can be changed according to the model.



**Accessories(cont.)**

**■ AJ036JCJ5CH**

Item	Descriptions	Code No	Qty	Rmark
	Drain Plug Out	DB67-00806A	1	Outdoor Unit
	Energy Label	DB68-05115A	2	
	Rubber Leg	DB73-20134A	4	
	Cap Drain	DB63-10355C	3	
	Installation Manual	DB68-05013A	1	
	Flare Nuts 3/8"	DB96-16155A	3	
	Flare Nuts 5/8"	DB96-16155B	2	



\* The design and shape can be changed according to the model.

---

## 3. Disassembly and Reassembly

---



### ■ Necessary Tools







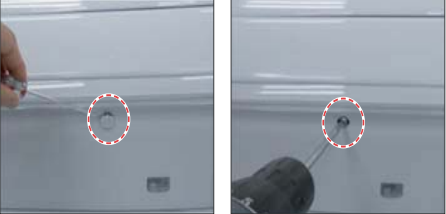

Item	Remark
+SCREW DRIVER	
MONKEY SPANNER	

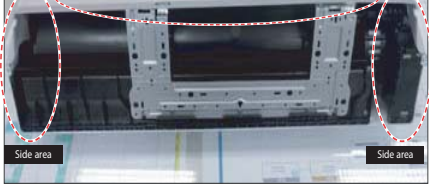

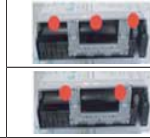

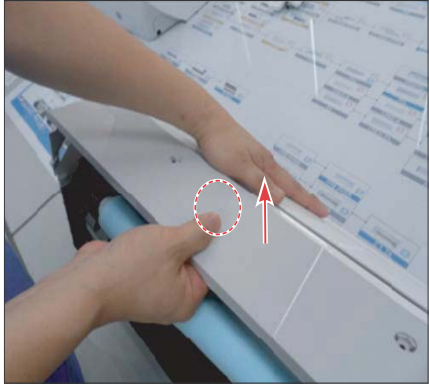

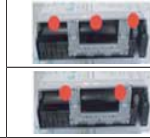
### 3-1 Indoor Unit

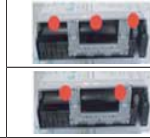
Take care of the electrical shock by contact on the charging parts before the discharge after power of.(If takes approximately 2 minutes to discharge.).

■ AJ007JNADCH/AJ009JNADCH/AJ012JNADCH/AJ018JNADCH/AJ024JNADCH

No	Parts	Procedure	Remark
1	PANEL-FRONT	<p>1) Stop the driving of air conditioner and shut off main power supply.</p> <p>2) Detach FILTER PRE from the PANEL FRONT.</p> <p>3) Cover Panel is assembled on bottom of indoor unit as shown in the figure. Remove the Cap Screw as shown on the right side and then remove the screw and separate the Cover Panel.</p>	   

No	Parts	Procedure	Remark						
		<p>4) Cover Panel is fixed to body by Hook in center area and side area.</p> <p>5) Separate the hook after pushing both end of Cover Panel as shown in the figure. (Watch out for the damage of the hook)</p> <p>6) Raise front part upward obliquely as shown in the figure and then remove the hooks</p>	 <table border="1" data-bbox="948 533 1378 707"> <thead> <tr> <th colspan="2">HOOK</th> </tr> </thead> <tbody> <tr> <td>9/12K</td> <td></td> </tr> <tr> <td>18/24/30K</td> <td></td> </tr> </tbody> </table>   	HOOK		9/12K		18/24/30K	
HOOK									
9/12K									
18/24/30K									

No	Parts	Procedure	Remark
		<p> <b>Caution</b></p> <p>Assembly of Cover Panel after service end.</p> <ul style="list-style-type: none"> <li>- Reassembly is in the reverse order of the removal.</li> <li>- Piping and drain hose must be careful not to damage and Progress must be done with both hands.</li> </ul>	  <p style="text-align: right;">Hook (Side)</p>  <p style="text-align: right;">Hook (Center)</p>  <p style="text-align: right;">Screw</p>  <p style="text-align: right;">Cap Screw</p>

No	Parts	Procedure	Remark
		<p>7) To detach the PANEL-FRONT from the main frame, unfasten 2 screws at the bottom. (use + Screw Driver)</p> <p>8) To detach the COVER-PANEL from the main frame, loosen 4 HOOK Structures. When separate the hook : Use the (-) screw Driver. (-)Screw Driver Insert the hook and then pull the hook as shown on the right side. (Watch out for the damage of the hook)</p>	   



No	Parts	Procedure	Remark
		<p>9) Remove the Panel Frame from the Main Frame as shown on the right side.</p>	

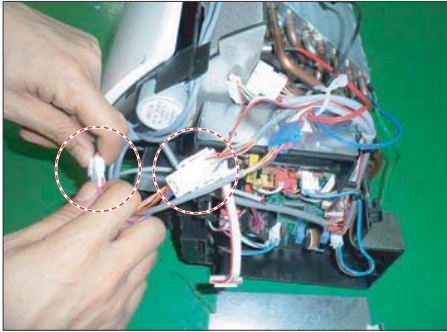
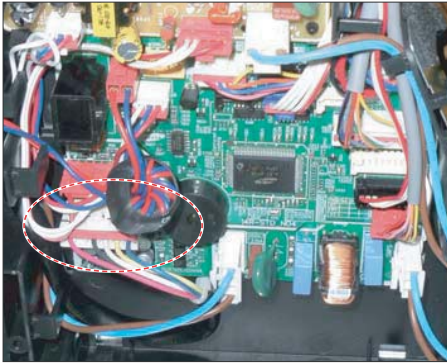
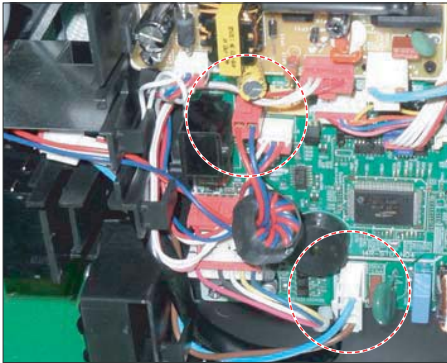
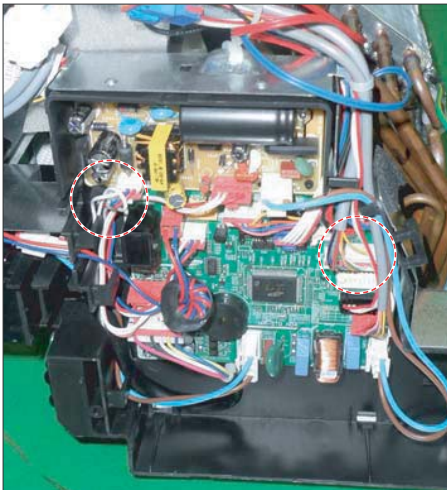

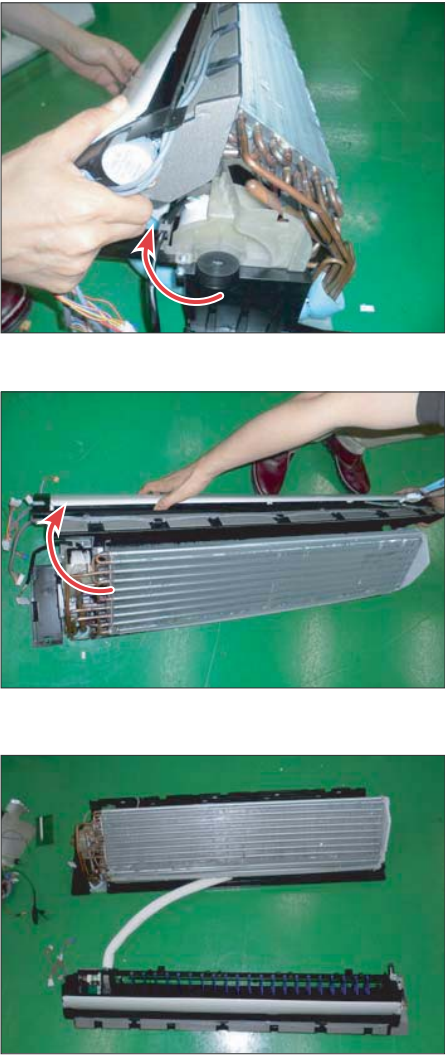

No	Parts	Procedure	Remark
2	CONTROL IN	<p>1) Loosen Stepping MOTOR Wire / BLADE Wire</p> <p>2) Loosen MOTOR Wire.  <b>⚠ Caution:</b>  When you separate the connector, pull pressing the locking button.</p> <p>3) Loosen the terminal block wires.  <b>⚠ Caution:</b>  When you separate the connector, pull pressing the locking button.</p> <p>4) Loosen the Thermistor wire connector, Display wire connector.  <b>⚠ Caution:</b>  When you separate the connector, pull pressing the locking button.</p>	   

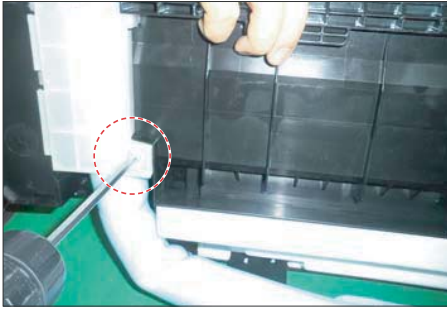

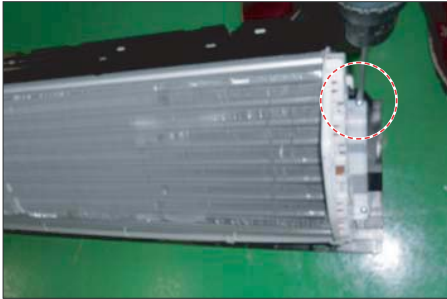
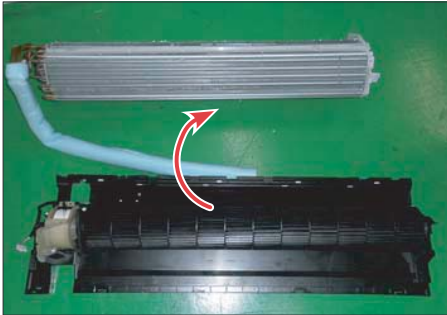

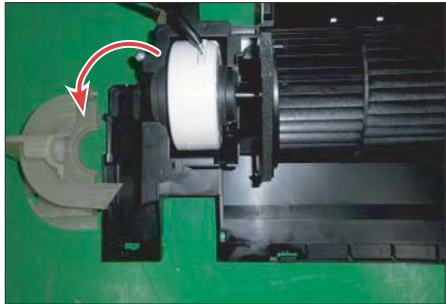
No	Parts	Procedure	Remark
2	CONTROL IN	5) Take off the CASE-CONTROL from the main frame after loosen the remaining connector. <b>⚠ Caution:</b> <b>When you separate the connector, pull pressing the locking button</b>	
3	TRAY DRAIN	1) To detach TRAY-DRAIN from the main frame, pull the bottom of the TRAY-DRAIN towards you.	

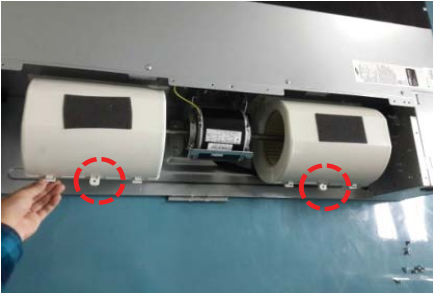

No	Parts	Procedure	Remark
4	Evaporator	<p>1) Detach the HOLDER PIPE.</p> <p>2) Unfasten the screw at the left side. (use + Screw Driver)</p> <p>3) Unfasten the screw at the right side. (use + Screw Driver)</p> <p>4) To detach Evaporator from the main frame, pull the bottom of the Evaporator towards you.</p>	   

No	Parts	Procedure	Remark
5	FAN MOTOR & CROSS FAN	<p>1) Unfasten the screw. (use + Screw Driver)</p> <p>2) Detach the FAN Motor case.</p> <p>3) Unfasten the screw a little. (use + Screw Driver)</p> <p>4) Pull the CROSS-FAN to the left side.</p>	   

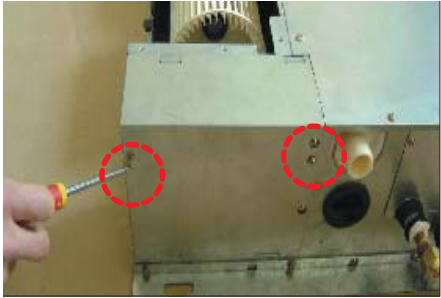

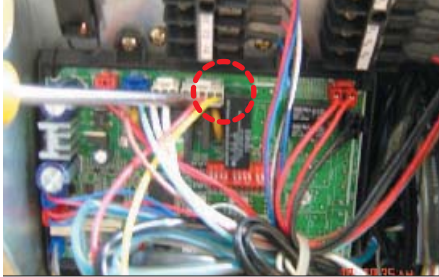
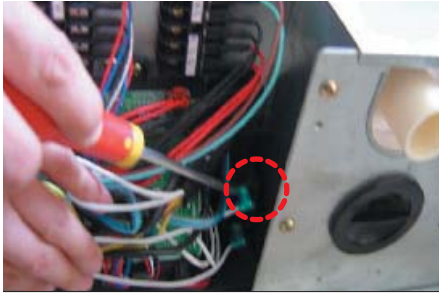
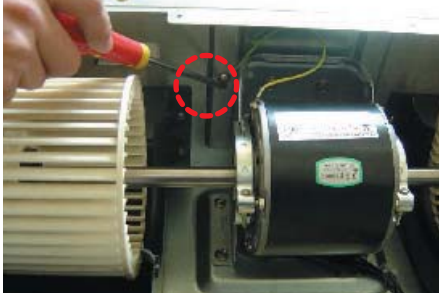
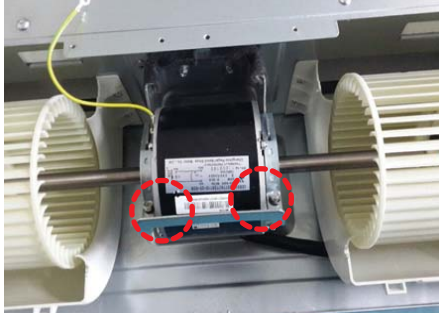
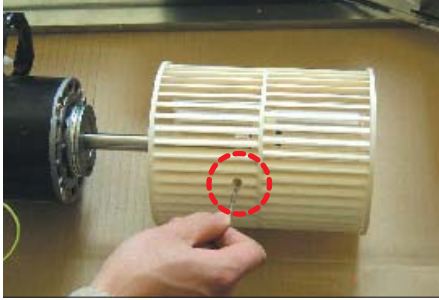
■ AJ009JNLDCH/AJ012JNLDCH



No	Parts	Procedure	Remark
1	Motor & Blower	<p>1) Disassemble the Cabinet Top Motor. - Unscrew 8 screws</p> <p>2) Disassemble 2 Cover Blower Uppers. - After unscrewing 2 screws</p> <p>- Disassemble the Cover Blower Upper with pushing its hook.</p> <p>3) Disassemble the Cover Control. - Unscrew 2 screws</p>	   

No	Parts	Procedure	Remark
		<p>4) Disassemble Motor Wires connected to the inside of PCB and connected to the Capacitor.</p>	 
		<p>5) Disassemble the Motor earth wire connected to the Partition. - Unscrew a screw</p>	
		<p>6) Disassemble the band Motor for fixing the Motor. - Unscrew 2 screws</p>	
		<p>7) After disassembling the Motor and Blower for the set, disassemble the Blower by use of 3mm wrench.</p>	

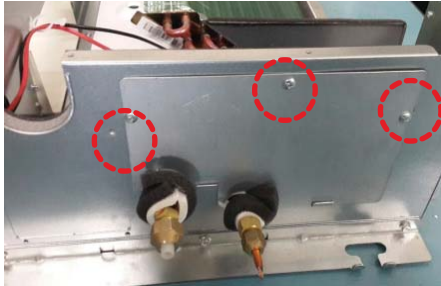
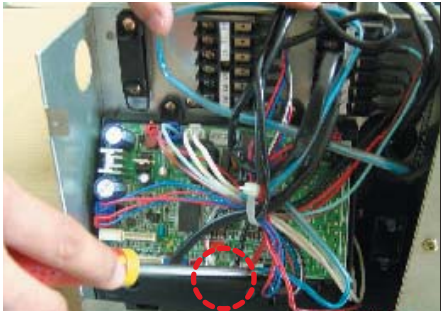
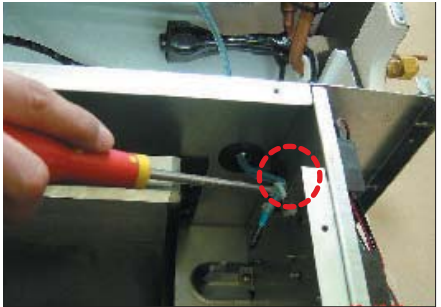
No	Parts	Procedure	Remark
2	Drain Pan	<p>1) Disassemble the Cabinet Top Evap. - Unscrew 11 screws</p> <p>2) Disassemble the Bracket Outlet Sub that fixes the Drain Pan equipped on the front of the set. - Unscrew 6 screws</p> <p>3) Disassemble the Drain Cushion from the set.</p>	  

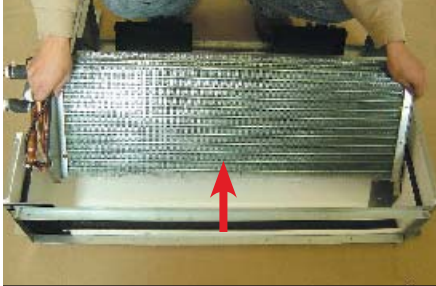
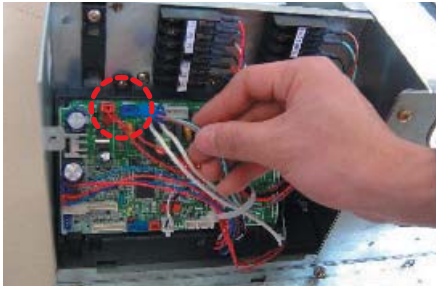

No	Parts	Procedure	Remark
3	Evaporator	<p>The Evaporator should be disassembled after disassembling the Cover Control 1-3) and the Drain Pan 2-1), 2-2), 2-3).</p> <p>1) Disassemble the Cover Pipe that fixes the high/low pressure Pipe. - Unscrew 3 screws</p> <p>2) Disassemble the refrigerant temperature sensor, Inlet air temperature sensor.</p> <p>3) Disassemble the Support Evap. LF that fixes the Evaporator. - Unscrew 2 screws</p> <p>4) Disassemble the Support Evap RH. - Unscrew 2 screws</p>	    

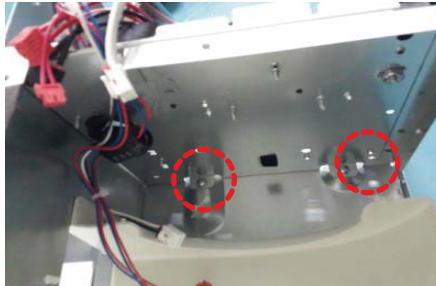

No	Parts	Procedure	Remark
		5) Disassemble the Evaporator form the set.	
4	Control In	<p>* The Control In should be disassembled after disassembling the Cover Control 1-3).</p> <p>1) Disassemble all Control Wires connected to the inside of PCB.</p> <p>2) In case of disassembling the PCB separately, disassemble the PCB from the case with pushing the hook after unscrewing the screw. - Unscrew 1 screw</p> <p>3) Disassemble the Case PCB from Case control in - Unscrew 2 screws</p> <p>4) In case of disassembling the Case Control, disassemble the Case Control from the set after unscrewing the screw connected to cover bottom fan. - Unscrew 2 screws</p>	   



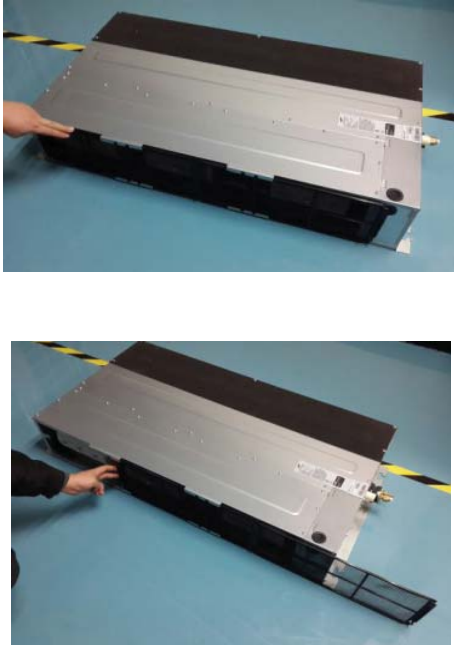

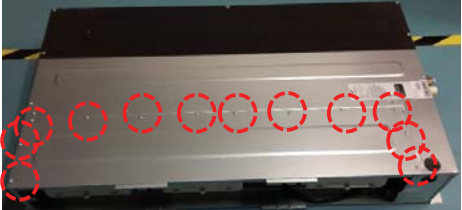
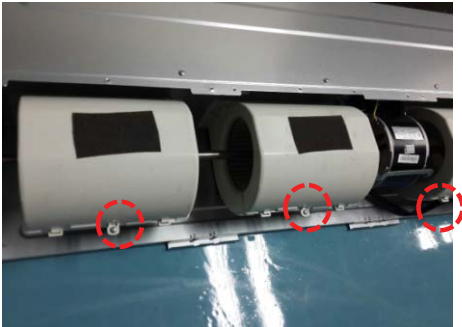
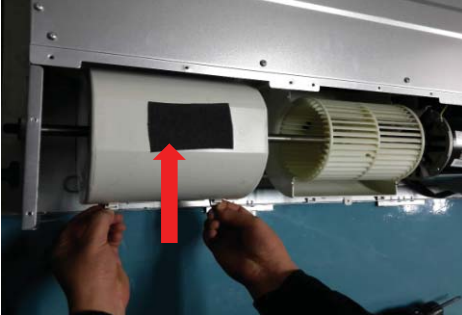

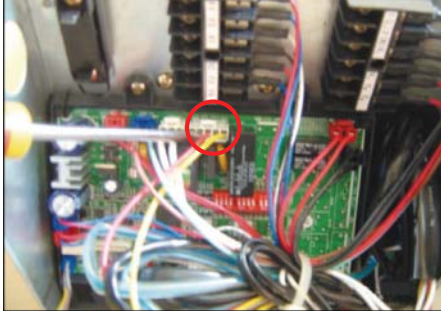
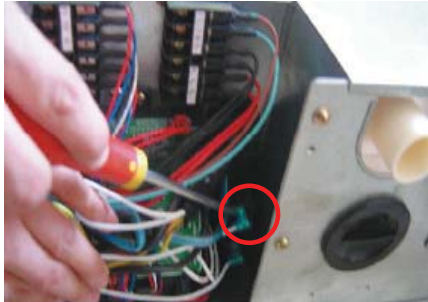

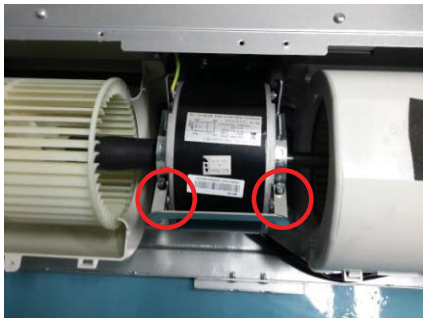
■ AJ018JNLDCH

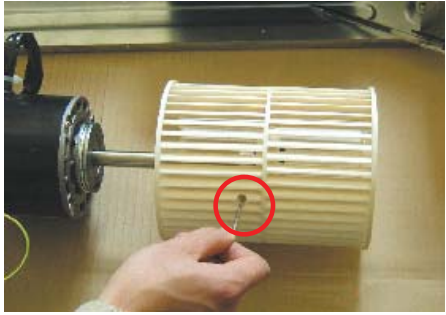
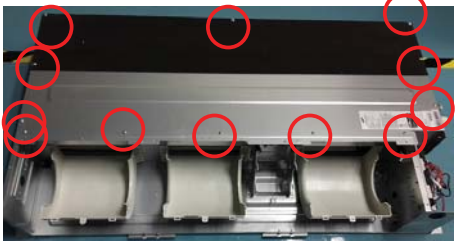
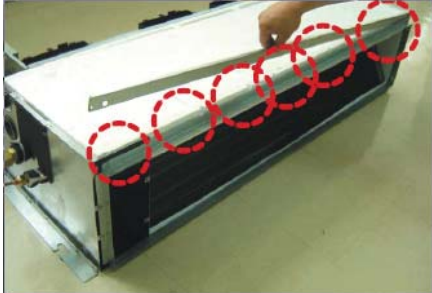

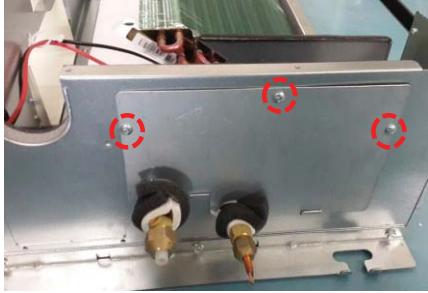

No	Parts	Procedure	Remark
1	Filter	1) Pull out the Filter as picture 1 or picture 2.	

No	Parts	Procedure	Remark
2	Blower & Motor	<p>1) After disassembling 13 indicating screws, detach Ass'y Cabinet-Top Motor.</p> <p>2) After disassembling 3 indicating screws, detach Ass'y Case Blower Upper.</p> <p>- Press the pothook of the Case Blower and detach Ass'y Case Blower Upper.</p>	  

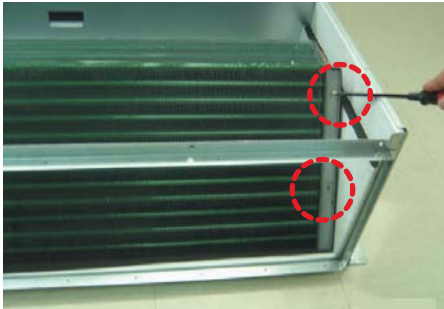
No	Parts	Procedure	Remark
		<p>3) After disassembling 2 indicating screws, detach the Cover Control.</p> <p>4) Detach the Motor Wire Connected to PCB and Capacitor.</p> <p>5) After disassembling the indicating screws, detach the wire connected to the Partition.</p> <p>6) After disassembling 2 indicating screws, detach the Ass'y Band Motor.</p>	    



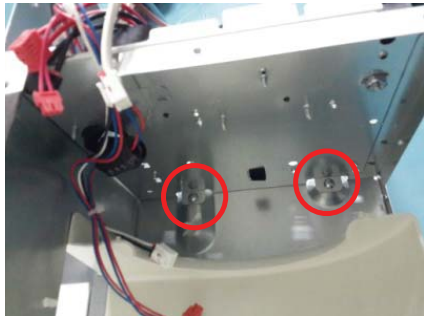

No	Parts	Procedure	Remark
		<p>7) After disassembling the Motor and Blowers, detach the Blowers from the axis of the Motor by 3mm inner hexagon spanner.</p>	
3	Drain Pan	<p>1) After disassembling 12 indicating screws, detach Ass'y Cabinet-Top Evap.</p> <p>2) After disassembling 6 indicating screws, detach the Bracket Outlet.</p> <p>3) Detach the Drain Pan.</p>	  



No	Parts	Procedure	Remark
4	Evaporator	<p>The Evaporator should be disassembled after disassembling the Cover Control 1-3) and the Drain Pan 2-1), 2-2), 2-3).</p> <p>1) Disassemble the Cover Pipe that fixes the high/low pressure Pipe. - Unscrew 3 screws</p> <p>2) Disassemble the refrigerant temperature sensor, Inlet air temperature sensor.</p> <p>3) After disassembling 2 indicating screws, detach Ass'y Support Evap LF.</p> <p>4) After disassembling 2 indicating screws, detach Ass'y Support Evap RH.</p>	    

No	Parts	Procedure	Remark
		5) Disassemble the Evaporator form the set.	
5	Control In	<p>The Control In should be disassembled after disassembling the Cover Control 1-3).</p> <p>1) Disassemble all Control Wires connected to the inside of PCB.</p> <p>2) In case of disassembling the PCB separately, disassemble the PCB from the case with pushing the hook.</p> <p>3) Disassemble the Case PCB from Case control in - Unscrew 2 screws</p> <p>4) If only the disassembly of Case Control is required, detach it from the set after disassembling 2 indicating screws.</p>	   





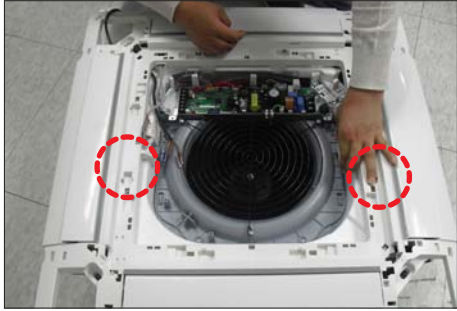

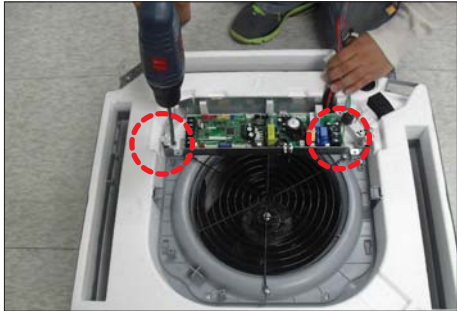
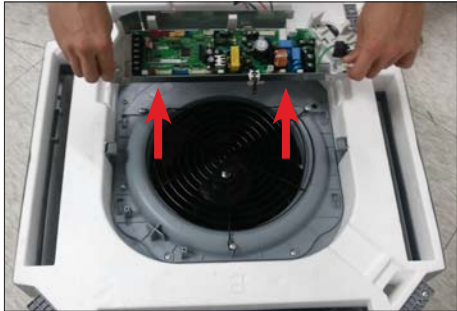

■ AJ009/012/018JNNDCH, AJ009/012/018NBDCH



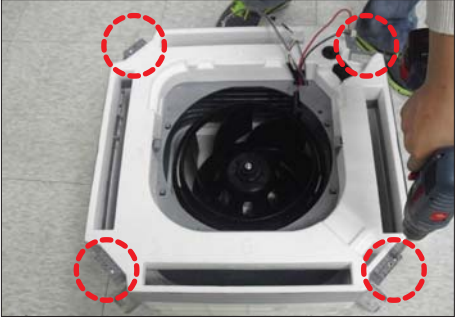
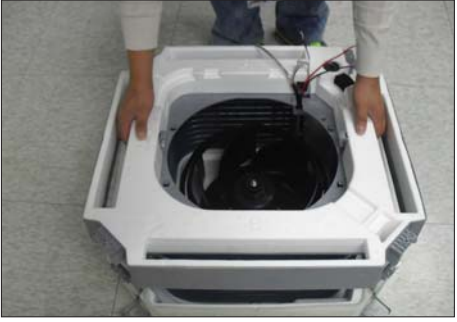

No	Parts	Procedure	Remark
1	Panel	<p>1) Pull both hooks and take the grille downward. Two safety clips are mounted to the front grille to prevent it from dropping.</p> <p>2) Detach the safety clip and take up the grille.</p> <p>3) Remove the 2 fixed screws to remove the Control-Box Cover. (Use +Screw Driver)</p> <p>4) Remove the Remocon-Receiver and Blade Connector Wire from the PBA. (3EA)</p> <p>5) Push the 4 panel corners and cover downwards to remove it.</p>	    

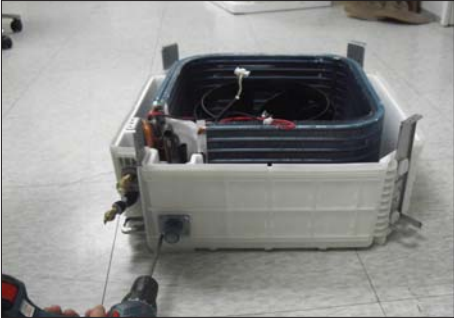
No	Parts	Procedure	Remark
		<p>6) Disassemble the bolts that are assembled with the indoor unit at the 4 panel corners.</p> <p>7) Press the Hangers at both sides of the panel inwards, to remove it from the indoor unit's hook. Remove the panel from the indoor unit.</p>	 
2	Control-Box	<p>1) Disconnect the Connector Wire that is connected to the indoor unit's PBA</p> <p>2) Unscrew the 2 fixed screws on both sides of the Control Box, and disassemble the Control Box from the indoor unit.(Use +Screw Driver)</p>	  

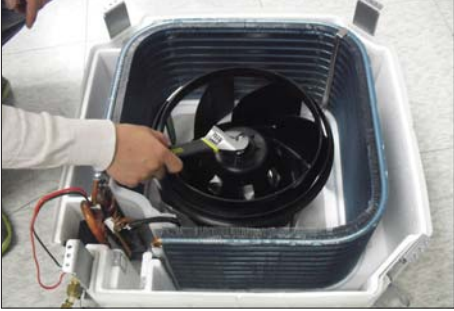

No	Parts	Procedure	Remark
3	Bell-Mouth	<p>1) Unscrew the screw fixed on the Bell-Mouth. (Use +Screw Driver)</p> <p>2) Push the Bell-Mouth in the direction opposite to where it's installed on the Control-Box to remove it.</p>	 
4	Drain Pan	<p>1) Unscrew the screws on the 4 corners of the indoor unit. (Use +Screw Driver)</p> <p>2) Remove the Drain Pan from the indoor unit.</p>	 

No	Parts	Procedure	Remark
5	Drain Pump & Hose	<p>1) Remove the 2 fixed screws and disconnect the white drainage hose from Drain Pump. (Use +Screw Driver)</p> <p>2) Remove the 2 screws and take the Drain-Hose out from the indoor unit to disassemble the transparent Drain-Hose fixed on the side of the indoor unit. (Use +Screw Driver)</p>	  
6	Evap. Temperature Sensor	<p>1) Use your hand to remove the temperature sensor attached to the Evap Pipe along with the fixing clip.</p>	

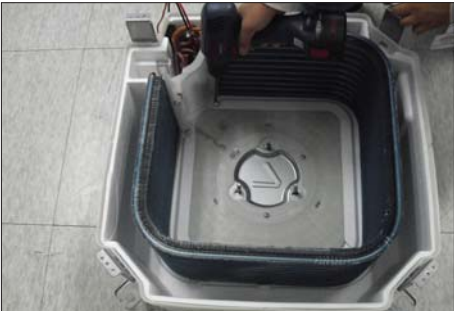
No	Parts	Procedure	Remark
7	Fan & Motor	<ol style="list-style-type: none"> <li>1) Turn the hexangular nut attached to the top of the Fan counterclockwise to remove it. Take the Fan out of the Motor.</li>   <li>2) Turn the three hexangular nuts on the Motor counterclockwise to remove the nuts. Take the Motor Wires attached to these three locations out with your hands prior to removing the Motor.</li> </ol>	  
8	Evaporator	<ol style="list-style-type: none"> <li>1) Remove the screws of the Steel Holder Evaps that are used to fix the Heat Exchanger, and then remove it. (Use +Screw Driver)</li>   <li>2) Remove the 2 fixing screws of the Partition Evap at the Heat Exchanger's In/Out Pipe. (Use +Screw Driver)</li> </ol>	 

No	Parts	Procedure	Remark
		<p>3) Remove the screw of the Cover Pipe that is used to fix the In/Out Pipe. Remove the In/Out Pipe. (Use +Screw Driver)</p> <p>4) Remove the Heat Exchanger from the indoor unit's cabinet.</p>	  



### 3-2 Outdoor Unit



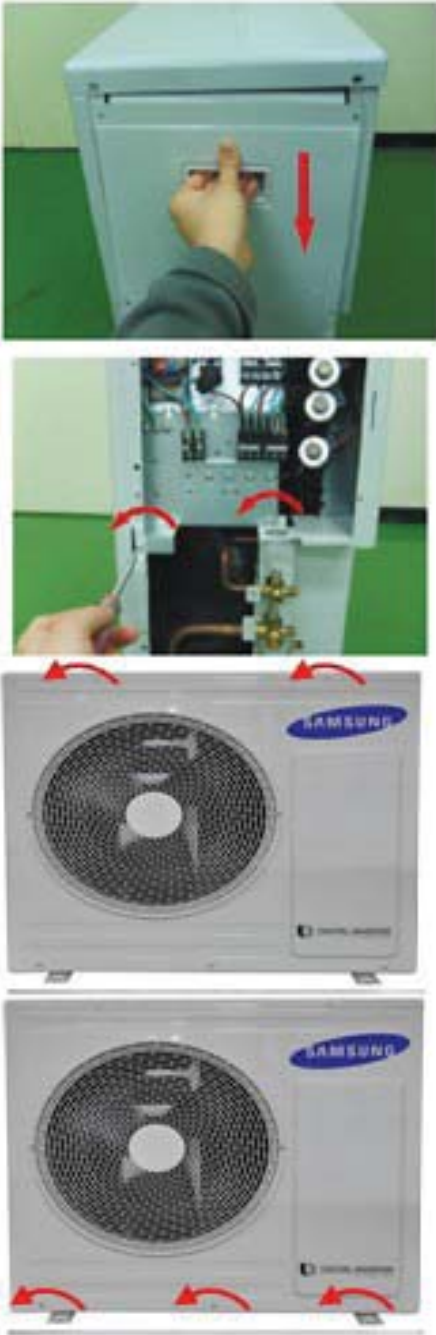

Take care of the electrical shock by contact on the charging parts before the discharge after power of.(If takes approximately 2 minutes to discharge.).

#### ■ AJ020JCJ2CH/AJ024JCJ3CH

No	Parts	Procedure	Remark
1	Common Work & Control Out	<p> <b>You must turn off the Power before disassembly.</b></p> <p>1) Loosen 7 fixing screws and detach the Cabinet side RH. (Use +Screw Driver.)</p> <p>2) Detach the Cable-Connector Wire from the Terminal-Block.</p> <p>3) Loosen 2 fixing screws of the Ass'y Control Out. (Use +Screw Driver.)</p> <p>4) Loosen 6 fixing screws and detach the Cabinet Upper. (Use +Screw Driver.)</p> <p>5) Loosen 2 fixing screws, 7 bolts and detach the Cabinet Front. (Use +Screw Driver.)</p>	



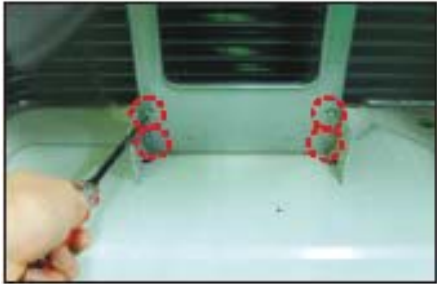

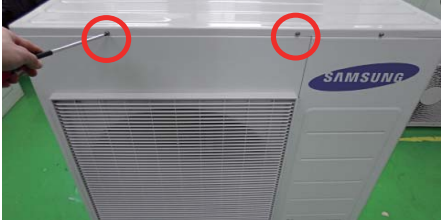

No	Parts	Procedure	Remark
			
		<p>6) Loosen 2 fixing screw and pull up the Control Box. (Use +Screw Driver.)</p> <p>7) Pull the felt and detach it.</p> <p>8) Detach the Terminal Cover and detach the comp lead wire.</p>	

No	Parts	Procedure	Remark
2	Fan & Moter	<ol style="list-style-type: none"> <li>1) Loosen the fixing nut and detach the Fan. (Use Monkey Spanner.)</li>   <li>2) Loosen 4 fixing bolts and detach the Motor. (Use +Screw Driver.)</li>   <li>3) Loosen 4 fixing bolts and detach the Bracket Motor. (Use +Screw Driver.)</li> </ol>	  
3	Heat Exchanger & Compressor	<ol style="list-style-type: none"> <li>1) Release the refrigerant at first.</li> <li>2) Disassemble the Inlet and Outlet Pipe by welding.</li> <li>3) Loosen the fixing screw of the Heat Exchanger. (Use +Screw Driver.)</li> <li>4) Detach the Heat Exchanger.</li>   <li>5) Loosen 3 nuts of the Compressor. (Use Monkey Spanner.)</li> <li>6) Detach the Compressor.</li> </ol>	 



■ AJ036JCJ5CH

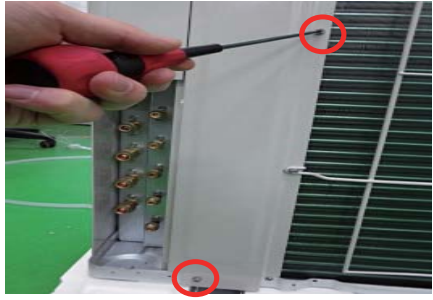

No	Parts	Procedure	Remark
1	Cabi Side RH	<p>⚠ You must turn off the Power before disassembly.</p> <p>1) Unscrew and remove 6 mounting screw in the Cabinet Side RH. (Use +Screw Driver)</p>	
2	Cabi Front RH	<p>1) Unscrew and remove 6 mounting screw in the Cabinet Side RH. (Use +Screw Driver)</p>	
3	Cabi Top	<p>1) Unscrew and remove 9 screws on each side of the Cabinet-Top. (Use +Screw Driver)</p>	

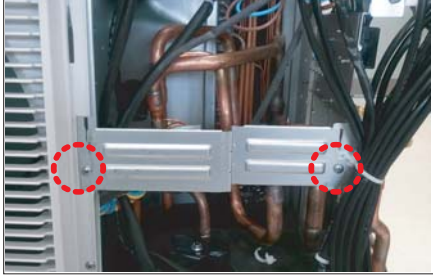
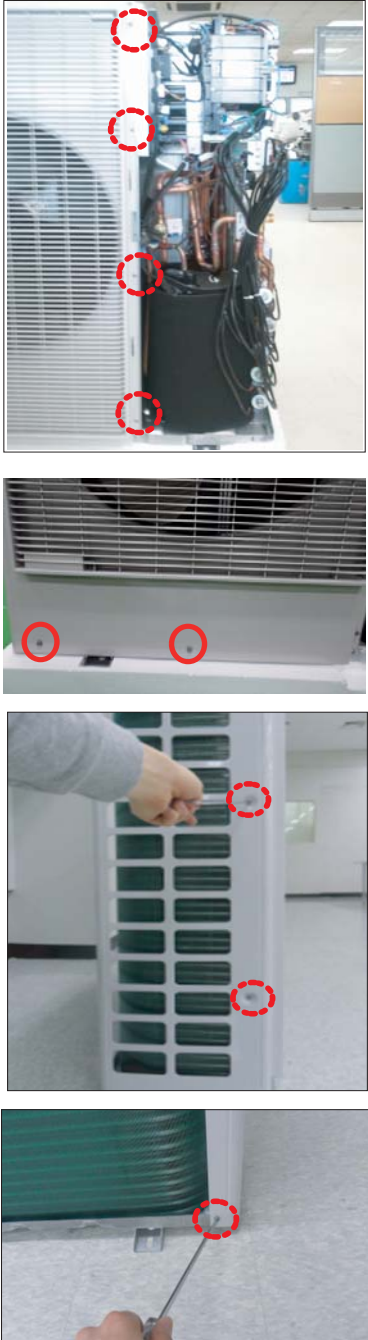

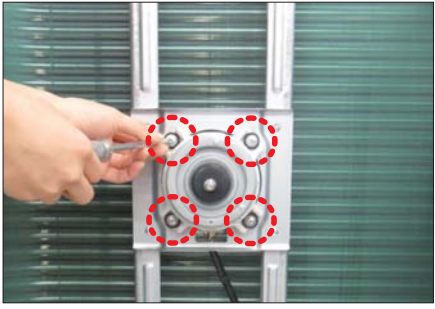
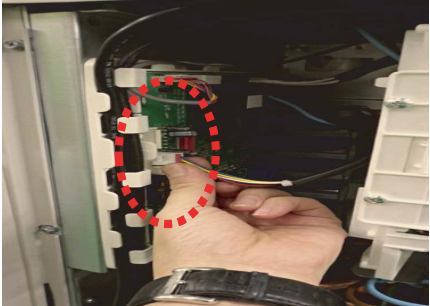
No	Parts	Procedure	Remark
4	Guard Cond	<p>1) Pull the sensor from Guard Cond.</p> <p>2) Unscrew and remove 4 screws in the Guard Cond. ( Use + Screw Driver )</p>	 
5	Cabi Back RH	<p>1) Pull the sensor from Cabi Back RH.</p> <p>2) Unscrew and remove 5 screws on each side of the Cabinet Back RH. ( Use + Screw Driver )</p> <p>3) Pull the hook of Cabi Back RH from the Bracket Valve.</p>	   

No	Parts	Procedure	Remark
6	Plate Case Control Support	1) Unscrew and remove 2 screws in the plate Case control Support. ( Use + Screw Driver )	
7	Cabi Back RH	1) Unscrew and remove 10 screws in the Cabinet-Front LF ( Use + Screw Driver )	

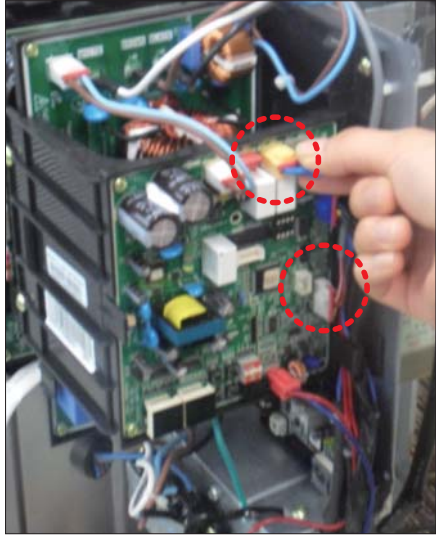
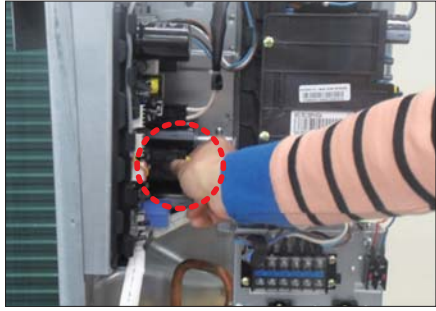
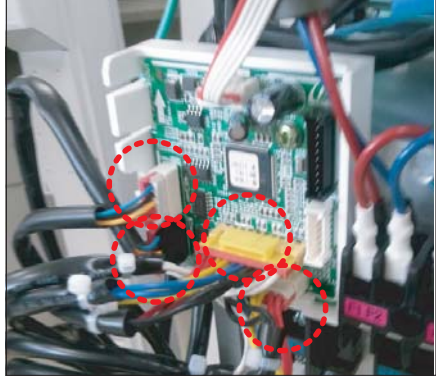
No	Parts	Procedure	Remark
8	Fan	1) Turn 2 mounting nuts as shown in the picture and remove it. (Use Adjustable Wrench)	
9	Motor	1) Separate the Fan Propeller. 2) Unscrew and remove the 8 Motor mounting screws. (Use +Screw Driver)  3) Disconnect the Motor wire From Ass'y Control Out.	 
10	Bracket Motor	1) Unscrew and remove 2 mounting screws in Bracket Motor. (Use +Screw Driver)	

No	Parts	Procedure	Remark
11	Control Out	<p>1) Disconnect 9 Connectors From Ass'y Control Out.</p> <p>2) Unscrew and remote 2 mounting screw in Control Out.(Use + Screw Driver)</p> <p>3) Separate Ass'y Control Out</p>	   

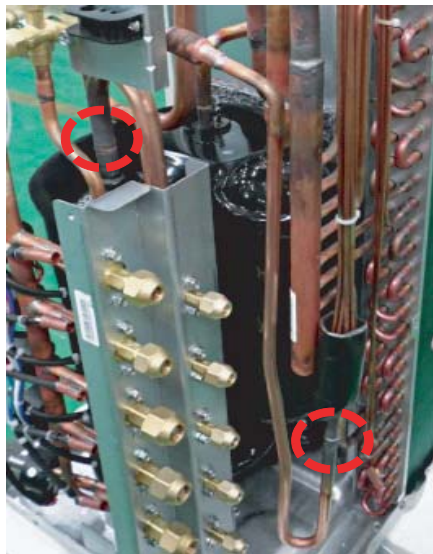
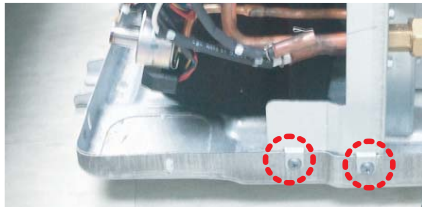
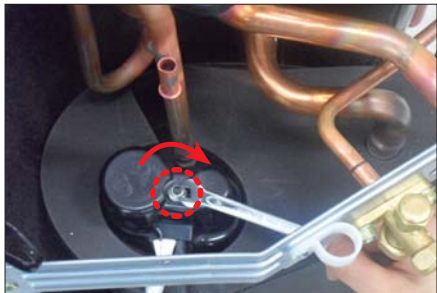
No	Parts	Procedure	Remark
12	Ass'y 4way Valve	1) Purge the Coolant first. 2) Separate the pipe from the Entrance/Exit using a welder.  <b>⚠ When removing the compressor, Heat Exchanger, and Pipe, purge the Coolant inside the Compressor completely and remove the pipe with a welding flame.</b>	
13	Assy EEV Valve	1) Separate the pipe from the Entrance/Exit using a welder.  2) Unscrew and remove 2 mounting screws in Service Valve. (Use +Screw Driver)	 
14	Compressor	1) Unscrew and remove 1 mounting nut in Cover Terminal. (Use Adjustable Wrench)	

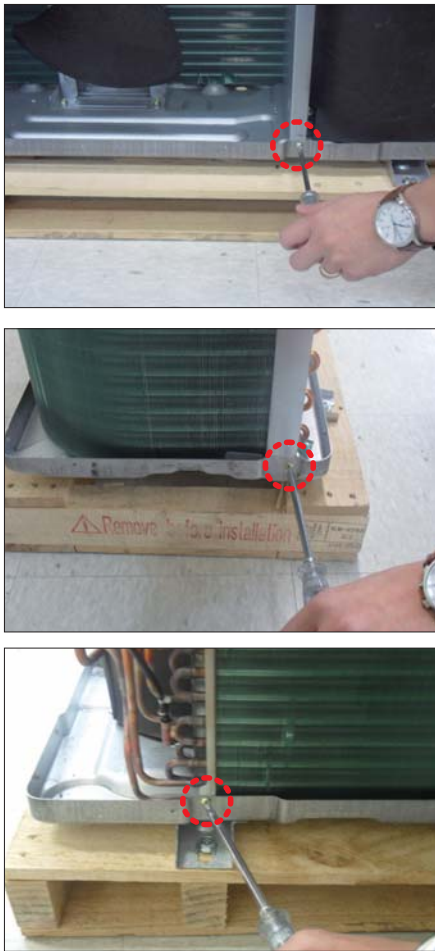

No	Parts	Procedure	Remark
		<p>2) Separate the Compressor Felt Sound.</p> <p>3) As shown in the picture, unscrew and remove 3 mounting screws from the bottom. (Use Adjustable Wrench)</p>	
15	Cond Out	1) Unscrew and remove 3 screws on each side of the Assy Cond Out. (Use +Screw Driver)	





























# MEMO

## 4. Troubleshooting

### 4-1 Display Error and Check Method

#### 4-1-1 Indoor unit

##### ■ AJ009JNNDCH/AJ012JNNDCH/AJ018JNNDCH

Abnormal conditions	LED lamp display				Remarks
	Operation	Defrost	Timer	Filter	
					
Power reset		X	X	X	
Error of temperature sensor in the indoor unit (Open/Short)	X		X	X	
Error of heat exchanger sensor in the indoor unit (Open/Short)			X	X	
Error of fan motor in the indoor unit	X	X		X	
Error of the outdoor temperature sensor Error of the condensor temperature sensor Error of the discharge temperature sensor		X		X	
No communication for 2 minutes between indoor and outdoor unit (communication error for more than 2minutes)	X			X	
Error of outdoor unit	X				
Detection of the float switch	X	X			
EEPROM error				X	
EEPROM option error					
Motion detect sensor error		X	X		
Mixed operation error	X	X	X		



















● On   ● Flickering   X Off

◆ If you turn off the air conditioner when the LED is flickering, the LED is also turned off.



■ AJ009JNLDCH/AJ012JNLDCH/AJ018JNLDCH

LED Display on the receiver & display unit









Abnormal conditions	Indicators					Remarks
	Concealed Type					
	Green	Red				
	Standard Type					
						
Power reset		X	X	X	X	
Error of temperature sensor in the indoor unit (Open/Short)	X	X		X	X	Displayed on appropriate indoor unit which is operating
Error of heat exchanger sensor in the indoor unit Error of heat exchanger OUT sensor in indoor unit Error of outlet temperature sensor in indoor unit (Open/Short): For heat pump models only		X		X	X	Displayed on appropriate indoor unit which is operating
Error of mixed operation	X		X		X	
Error of outdoor temperature sensor Error of COND sensor Error of DISCHARGE sensor		X	X		X	Displayed on appropriate indoor unit which is operating Displayed on outdoor unit
1. No communication for 2 minutes between indoor units (Communication error for more than 2 minutes) 2. Indoor unit receiving the communication error from outdoor unit 3. Outdoor unit tracking 3 minutes error 4. When sending the communication error from the outdoor unit, the mismatching of the communication numbers and installed numbers after completion of tracking. (Communication error for more than 2 minutes)	X	X			X	1. Error of indoor unit: Displayed on the indoor unit regardless of operation 2. Error of outdoor unit: Displayed on the indoor unit which is operating

● On    ◐ Flickering    X Off

- ◆ If you turn off the air conditioner when the LED is flickering, the LED is also turned off.
- ◆ If you re-operate the air conditioner, it operates normally at first, then detect an error again.

## ■ AJ009JNLDCH/AJ012JNLDCH/AJ018JNLDCH

### LED Display on the receiver & display unit

Abnormal conditions	Indicators					Remarks
	Concealed Type					
	Green	Red				
	Standard Type					
						
Self-diagnostic error (including the indoor unit not detected) 1. Error of electronic expansion valve close 2. Error of electronic expansion valve open 3. Breakaway of EVA OUT sensor 4. Breakaway of EVA IN sensor	X	X	●	●	●	Displayed on appropriate indoor unit which is operating Displayed on outdoor unit
5. Breakaway of COND MID sensor 6. 2nd detection of refrigerant completely leak 7. 2nd detection of high temperature COND 8. 2nd detection of high temperature DISCHARGE 9. COMP DOWN due to 2nd detection of low pressure switch 10. Error of reverse phase 11. Compressor down due to 6th detection of freezing 12. Self-diagnosis of condensation sensor (G8, G9) 13. Compressor down due to condensation ratio control	X	X	●	●	●	Displayed on appropriate indoor unit which is operating Displayed on outdoor unit
Error of float switch	X	X	X	●	●	
Error of setting option switches for optional accessories	X	X	●	X	●	
EEPROM error	●	X	●	●	X	
EEPROM option error	●	X	●	●	●	

● On    ● Flickering    X Off

- ◆ If you turn off the air conditioner when the LED is flickering, the LED is also turned off.
- ◆ If you re-operate the air conditioner, it operates normally at first, then detect an error again.

■ AJ007JNADCH/AJ009JNADCH/AJ012JNADCH/AJ018JNADCH/AJ024JNADCH





**LED Display on the receiver & display unit**

Error indicator				Error	Measures to take by an installer
88 Display	LED Display				
	LED 1	LED 2	LED 3		
E 10 1	○	◐	◐	Communication Error between Indoor and outdoor unit	1. Check the connection wire between indoor and outdoor unit. (whether the power cable and communication cable is crossed or not)
E 12 1	○	◐	○	Error on indoor temperature sensor	1. Check the connection of the connector
E 122, E 123	◐	◐	○	Error on indoor heat exchanger	1. Check the connection of the connector
E 154	○	○	◐	Error on indoor fan motor	1. Check the connection of the connector 2. Remove foreign substance (Check for the cause that restrains motor)
88 display and all LED blinks	◐	◐	◐	EEPROM/Option error	1. Re-set options
E 162, E 163					
E 422	●	○	◐	Refrigerant flow blocking Error	1. Check if the service valve is completely open. 2. Check if there's any blockage in the refrigerant pipe which connects indoor and outdoor unit. 3. Check for refrigerant leak.
E 554	* Above LED pattern is displayed when there's error is occurred on outdoor unit. Check the LED display on outdoor unit for the details.			Lack of Refrigerant (For Inverter model only)	1. Check if sufficient amount of additional refrigerant was charged for the pipe length that exceeds 7.5m. 2. Check for refrigerant leak between valve and pipe connection.

● On   ◐ Flickering   ✕ Off

- ◆ If you turn off the air conditioner when the LED is flickering, the LED is also turned off.
- ◆ If you re-operate the air conditioner, it operates normally at first, then detect an error again.

■ AJ\*\*\*NBNDCH

Abnormal conditions	LED lamp display			
	Operation	Defrost	Timer	Filter
				
Power reset	●	X	X	X
Error of temperature sensor in the indoor unit (Open/Short)	X	●	X	X
Error of heat exchanger sensor in the indoor unit (Open/Short)	●	●	X	X
Error of fan motor in the indoor unit	X	X	●	X
Error of the outdoor temperature sensor Error of the condensor temperature sensor Error of the discharge temperature sensor	●	X	●	X
No communication for 2 minutes between indoor and outdoor unit (communication error for more than 2 minutes)	X	●	●	X
Error of outdoor unit Error of the terminal block thermal fuse (Open)	X	●	●	●
Detection of the float switch	X	X	●	●
EEPROM error EEPROM option error	●	●	●	●
Motion detect sensor error	●	X	X	●
Mixed operation error	X	X	X	●
Outdoor valve clogging error	●	X	●	●
Miss matching error between indoor unit and outdoor unit	●	●	X	●

● : On, ◐ : Flickering, X : Off

- If you turn off the air conditioner when the LED is flickering, the LED is also turned off.

## 4-1-2 Outdoor unit

### ■ AJ020JCJ2CH/AJ024JCJ3CH/AJ036JCJ5CH

The table below give indication about self diagnostic routine. Some of error code requires activities exclusively for Authorise Service Center.

◆ The error indicated on the PCB display of outdoor unit

DISPLAY		EXPLANATION (The error indicated on the PCB display of outdoor unit)	REMARK
E1	01	Communiaction error(indoor unable to receive data)	Check electrical connection and setting
E1	02	Outdoor unit communication error(Abnormal data from indoor unit over 60 packet)	Check electrical connection and setting
E1	21	Indoor unit room temperature sensor error (Open/Short)	
E1	22	Indoor unit heat exchanger in temperature sensor error (Open/Short)	
E1	23	Indoor unit heat exchanger out temperature sensor error (Open/Short)	
E1	28	Indoor unit sensor error-Evaporator pipe in sensor - Self diagnosis	
E1	29	Indoor unit sensor error-Evaporator pipe out sensor - Self diagnosis	
E1	54	Indoor Unit FAN Error	
E1	61	More than two indoor units cool and heat simultaneously	
E1	62	Indoor Unit EEPROM Error	
E1	63	Indoor Unit EEPROM Option Error	
E1	71	EVA-MID BREAK AWAY	
E1	72	EVA-IN BREAK AWAY	
E1	73	EVA-OUT BREAK AWAY	
E1	90	Failure of pipe check operation	Check piping connection and setting
E1	99	No pipe check operation check - occasion : try to operation after the installation through auto addressing mode without pipe check operation.	Check setting
E2	01	The number of Indoor unit mismatched	Check electrical connection and setting
E2	02	Communication error between the outdoor and indoor unit	Check electrical connection and setting
E2	03	Outdoor communication error between main micom and inverter micom	
E2	06	Outdoor communication error between main micom and hub micom	
E2	21	Outside temperature sensor error(Short/Open) - Error level: over 4.9V(-50°C) under 0.4V(93°C)	
E2	37	Condenser temperature sensor error(Short/Open) - Error level: over 4.9V(-50°C) under 0.4V(93°C)	
E2	46	Outdoor unit sensor error - Condenser out sensor(Short/Open) - Self diagnosis	
E2	51	Compressor Discharge temperature sensor error	
E2	61	Compressor discharge sensor detached - Self diagnosis	
E3	20	Compressor OLP sensor error (Short/Open) - Error condition : outdoor temperature under -20°C - Error level : over 4.95V(-30°C) under 0.5V(151°C)	
E3	30	EvaIn1 Sensor Short/Open	
E3	31	EvaIn2 Sensor Short/Open	
E3	32	EvaIn3 Sensor Short/Open	
E3	33	EvaIn4 Sensor Short/Open	
E3	34	EvaIn5 Sensor Short/Open	
E3	35	EvaOut1 Sensor Short/Open	

■ AJ020JCJ2CH/AJ024JCJ3CH/AJ036JCJ5CH

DISPLAY	EXPLANATION (The error indicated on the PCB display of outdoor unit)	REMARK
E3 36	EvaOut2 Sensor Short/Open	
E3 37	EvaOut3 Sensor Short/Open	
E3 38	EvaOut4 Sensor Short/Open	
E3 39	EvaOut5 Sensor Short/Open	
E4 01	Outdoor unit freezing(Compressor stop)	check pipe lenght, indoor unit filter, refrigerant leakage/charge and service port
E4 04	Outdoor unit overload - Safety control(Compressor stop)	check pipe lenght, refrigerant leakage/charge
E4 16	Outdoor unit high discharge temperature - Safety control (Compressor stop)	check pipe lenght, refrigerant leakage/charge
E4 19	Outdoor unit EEV open (Stopped indoor unit's) -Self diagnosis	
E4 22	Outdoor unit EEV open (operating indoor unit's) -Self diagnosis	
E4 40	High temperature(over 30°C) of outdoor as heating mode	
E4 41	Low temperature(under -10°C) of outdoor as cooling mode	
E4 58	Outdoor Fan Error	
E4 60	Communication cable mismatched between indoor and outdoor unit	Check electrical connection
E4 61	Inverter compressor starting failure (5 times)	
E4 62	Compressor trip by input current control mode (PFC over current)	
E4 63	Compressor trip by OLP temperature control mode	
E4 64	Over current	
E4 65	Compressor Vlimit Error	
E4 66	DC link Voltage error (under 150V, over 410V)	
E4 67	Abnormal compressor running (Compressor Rotation Error)	
E4 68	Current sensor error	
E4 69	DC link Voltage sensor error	
E4 70	Outdoor unit EEPROM Error	
E4 72	Inverter micom zero-crossing error	
E4 83	Over voltage Error	

## 4-2 Setting Option Setup Method

### 4-2-1 Setting an indoor unit address and installation option

#### Setting Option

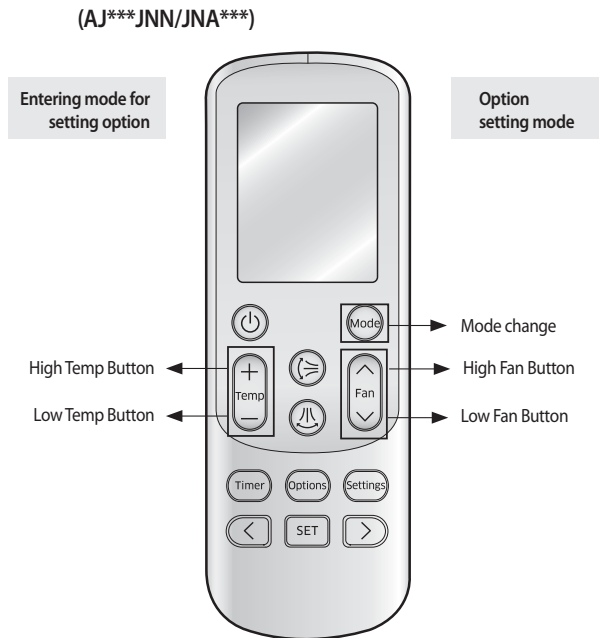

#### ◆ Setting Option

1. Remove batteries from the remote controller
2. Insert batteries and enter the option setting mode while pressing High Temp button and Low Temp button.
3. Each time you press Low Fan button, 7-seg on left side is increased by "1" and each time you press High Fan button, 7-seg on right side is increased by "1"
4. You press **Mode** button to move to the next setting page.
5. After setting option, press **Mode** button to check whether the option code you input is correct or not.

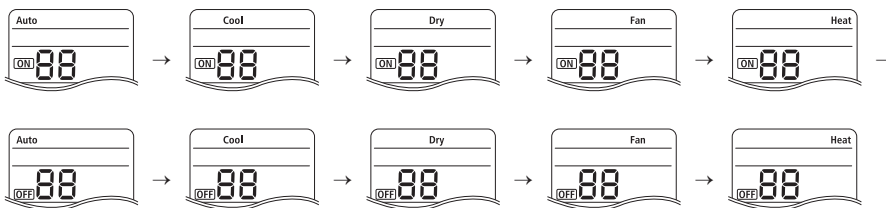

6. Press operation button with the direction of remote control for set.



- SEG1, SEG7, SEG13, SEG19 are not set as page option.
- Set the SEG1, SEG7 as ON status and SEG13, SEG19 as OFF status.  
EX) Set the each option separately since you cannot set the ADDRESS setting and indoor unit installation setting option at the same time.

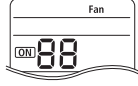
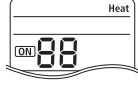

## The procedure of setting option

Operation	Indication
<p>* Step 1</p> <ol style="list-style-type: none"> <li>1. Remove the batteries from the remote controller.</li> <li>2. Insert batteries while pressing High Temp Button and Low Temp Button.</li> </ol>	
<p>* Step 2</p> <ol style="list-style-type: none"> <li>1. Press Low Fan button to enter SEG2 value.</li> <li>2. Press High Fan button to enter SEG3 value.</li> </ol>	
<p>* Step 3</p> <p>Press Mode button to be change to Cool mode in the ON status.</p> <ol style="list-style-type: none"> <li>1. Press Low Fan button to enter SEG4 value.</li> <li>2. Press High Fan button to enter SEG5 value.</li> </ol>	
<p>* Step 4</p> <p>Press Mode button to be changed to DRY mode in the ON status.</p> <ol style="list-style-type: none"> <li>1. Press Low Fan button to enter SEG6.</li> <li>2. Press High Fan button to enter SEG8.</li> </ol>	
<p>* Step 5</p> <p>Press Mode button to be changed to FAN mode in the ON status.</p> <ol style="list-style-type: none"> <li>1. Press Low Fan button to enter SEG9 value.</li> <li>2. Press High Fan button to enter SEG10 value.</li> </ol>	
<p>* Step 6</p> <p>Press Mode button to be changed to HEAT mode in the ON status.</p> <ol style="list-style-type: none"> <li>1. Press Low Fan button to enter SEG11 value.</li> <li>2. Press High Fan button to enter SEG12value</li> </ol>	
<p>* Step 7</p> <p>Press Mode button to be changed to AUTO mode in the OFF status.</p> <ol style="list-style-type: none"> <li>1. Press Fan button to enter SEG14 value.</li> <li>2. Press High Fan button to enter SEG15 value.</li> </ol>	
<p>* Step 8</p> <p>Press Mode button to be changed to Cool mode in the OFF status.</p> <ol style="list-style-type: none"> <li>1. Press Low Fan button to enter SEG16 value.</li> <li>2. Press High Fan button to enter SEG17 value.</li> </ol>	
<p>* Step 9</p> <p>Press Mode button to be changed to DRY mode in the OFF status.</p> <ol style="list-style-type: none"> <li>1. Press Low Fan button to enter SEG18 value.</li> <li>2. Press High Fan button to enter SEG20 value.</li> </ol>	
<p>* Step 10</p> <p>Press Mode button to be changed to FAN mode in OFF status</p> <ol style="list-style-type: none"> <li>1. Press Low Fan button to enter SEG21 value.</li> <li>2. Press High Fan button to enter SEG22 value.</li> </ol>	
<p>* Step 11</p> <p>Press Mode button to be changed to HEAT mode in the OFF status</p> <ol style="list-style-type: none"> <li>1. Press Low Fan button to enter SEG23 value.</li> <li>2. Press High Fan button to enter SEG24 value.</li> </ol>	
<p>* Step 12</p> <p>Press Mode button to check whether the option code you entered is correct or not. Press operation button to enter option.</p>	

## Setting an indoor unit address (MAIN/RMC)

- Check whether power is supplied or not.
  - When the indoor unit is not plugged in, there should be additional power supply in the indoor unit.
- The panel(display ) should be connected to an indoor unit to receive option.
- Before installing the indoor unit, assign an address to the indoor unit according to the air conditioning system plan.
- Assign an indoor unit address by wireless remote controller.
  - The initial setting status of indoor unit ADDRESS(MAIN/RMC) is "0A0000-100000-200000-300000"
  - There is no need to assign extra ADDRESS for 1:1 installation between indoor unit and outdoor unit.

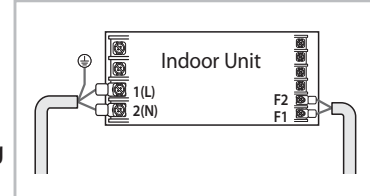

Option No. : 0AXXXX-1XXXXX-2XXXXX-3XXXXX

Option	SEG1		SEG2		SEG3		SEG4		SEG5		SEG6			
Explanation	PAGE		MODE		Setting Main address		100-digit of indoor unit address		10-digit of indoor unit		A single digit of indoor unit			
Remote Controller Display														
Indication and Details	Indication	Details	Indication	Details	Indication	Details	Indication	Details	Indication	Details	Indication	Details		
	0		A		0	No Main address			0~9	10-digit	0~9	10-digit	0~9	A single digit
					1	Main address setting mode								
Option	SEG7		SEG8		SEG9		SEG10		SEG11		SEG12			
Explanation	PAGE				Setting RMC address				Group channel(*16)		Group address			
Remote Controller Display														
Indication and Details	Indication	Details	Indication	Details	Indication	Details	Indication	Details	Indication	Details	Indication	Details		
	1				0	No RMC address					RMC1	1~F	RMC2	1~F
					1	RMC address setting mode								

※ You must set RMC address setting mode when using the centralized Control .



- When "A"~"F" is entered to SEG4~6, the indoor unit MAIN ADDRESS is not changed.
- If you set the SEG 3 as 0, the indoor unit will maintain the previous MAIN ADDRESS even if you input the option value of SEG4~6.
- If you set the SEG 9 as 0, the indoor unit will maintain previous RMC ADDRESS even if you input the option value of SEG11~12.

5. The MAIN address is for communication between the indoor unit and the outdoor unit. Therefore, you must set it to operate the air conditioner properly.

### Setting an indoor unit installation option (suitable for the condition of each installation location)

1. Check whether power is supplied or not.
  - When the indoor unit is not plugged in, there should be additional power supply in the indoor unit.
2. The panel(display ) should be connected to an indoor unit to receive option.
3. Before installing the indoor unit, assign an option to the indoor unit according to the air conditioning system plan.
  - The default setting of an indoor unit installation option is "02000-100000-200000-300000".
  - Individual control of a remote controller(SEG20) is The function that controls an indoor unit individually when there is more than one indoor unit.
4. Set the indoor unit option by wireless remote controller.
  - When entering Address option, connect remote controller receiver.

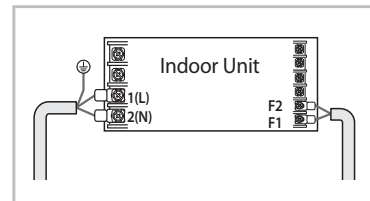

Option	SEG1		SEG2		SEG3		SEG4		SEG5		SEG6	
Explanation	PAGE		MODE						Central control			
Indication and Details	Indication	Details	Indication	Details	Indication	Details	Indication	Details	Indication	Details	Indication	Details
	0		2		0		0		0	No use	0	
									1	Use		
Option	SEG7		SEG8		SEG9		SEG10		SEG11		SEG12	
Explanation	PAGE										Master / Slave	
Indication and Details	Indication	Details	Indication	Details	Indication	Details	Indication	Details	Indication	Details	Indication	Details
	1		0		0		0		0		0	Slave
											1	Master
Option	SEG13		SEG14		SEG15		SEG16		SEG17		SEG18	
Explanation	PAGE		External control		External control output				Buzzer			
Indication and Details	Indication	Details	Indication	Details	Indication	Details	Indication	Details	Indication	Details	Indication	Details
	2		0	No use	0	Thermo ON	0		0	Use	0	
		1	On/Off control									
		2	Off control	1	Operation ON			1	No Use			
		3	Window On/Off control <sup>1)</sup>									
Option	SEG19		SEG20		SEG21		SEG22		SEG23		SEG24	
Explanation	PAGE											
Indication and Details	Indication	Details	Indication	Details	Indication	Details	Indication	Details	Indication	Details	Indication	Details
	3		0		0		0		0		0	

► If you input a number other than 0~4 of the individual control of the indoor unit(SEG20), the indoor is set as "indoor 1".

- 1) The window on/off function applies to the following unit
  - AJN\*\*/AR\*\*

## 4-2-2 Changing a particular option

MODEL	OPTION CODE
AJ007JNADCH	010025-16623A-271416-372A04
AJ009JNADCH	010025-16624A-271920-372A04
AJ012JNADCH	010025-16626B-272328-372B04
AJ018JNADCH	010025-15622A-27323C-372604
AJ024JNADCH	010025-15625C-274450-372604
AJ009JNLDCH	015201-14023E-200001-300000
AJ012JNLDCH	015201-160370-200001-300000
AJ018JNLDCH	011224-1940E6-200001-300000
AJ009JNNDCH	01507F-1660F8-231A21-300100
AJ012JNNDCH	01507F-166219-232328-300100
AJ018JNNDCH	01507F-17625D-23343C-300100

If you are going to use up to SEG 24, please refer to following instruction.

SEG 18 :

	Not in use	Use
Change temperature display	0(Celsius)	1(Fahrenheit)
Sound Mute	0	2

If you want to use multiple functions, add each of the 'use' value of the function you want to used and input the final addition as option value. (Use Fahrenheit + Sound mute : 1 + 2 = 3)

Ex) 044217-1d00e6-200000-300000





When using Sound mute : 044217-1d00e6-200002-300000

When using Fahrenheit and Sound mute : 044217-1d00e6-200003-300000

Option	AJ009NBNDCH/AA	AJ012NBNDCH/AA	AJ018NBNDCH/AA
SEG1~6	0150CF	0150CF	0150CF
SEG7~12	1940F8	194419	19445D
SEG13~18	201A21	202328	20343C
SEG19~24	300000	300000	300040
SEG25~30	020000	020000	020000
SEG31~36	120000	120000	120000
SEG37~42	200000	200000	200000
SEG43~48	300100	300100	300100
SEG49~54	030000	030000	030000
SEG55~60	100000	100000	100000
SEG61~66	200000	200000	200000
SEG67~72	300000	300000	300000

## 4-3 Items to be checked first

1. The input voltage should be rating voltage  $\pm 10\%$  range.  
The air conditioner may not operate properly if the voltage is out of this range.
2. Is the link cable linking the indoor unit and the outdoor unit linked properly?  
The indoor unit and the outdoor unit shall be linked by 4 cables.  
Check the terminals if the indoor unit and outdoor unit are properly linked by the same number of cables.  
Otherwise the air conditioner may not operate properly.
3. When a problem occurs due to the contents illustrated in the table below it is a symptom not related to the malfunction of the air conditioner.

No	Operation of air conditioner	Explanation
1	In a COOL operation mode, the compressor does not operate at a room temperature higher than the setting temperature that the INDOOR FAN should operate. In a HEAT operation mode, the compressor does not operate at a room temperature lower than the setting temperature that indoor fan should operate.	In happens after a delay of 3 minutes when the compressor is reoperated. The same phenomenon occurs when a power is on. As a phenomenon that the compressor is reoperated after a delay of 3 minutes, the indoor fan is adjusted automatically with reference to a temperature of the air blew
2	Fan speed setting is not allowed in AUTO(  ) or DRY(  ) mode.	The speed of the indoor fan is set to LL in DRY mode. Fan speed is 5 steps and is selected automatically in AUTO mode.
3	Compressor stops operation intermittently in DRY(  ) mode.	Compressor operation is controlled automatically in DRY mode depending on the room temperature and humidity.
4	Compressor of the outdoor unit is operating although it is turned off in a HEAT mode.	When the unit is turned off while de-ice is activated, the compressor continues operation for up to 12 minutes (maximum) until the deice is completed.
5	Timer LED(  ) only of the indoor unit lights up and the air conditioner does not operate.	Timer is being activated and the unit is in ready mode. The unit operates normally if the timer operation is cancelled.
6	The compressor and indoor fan stop intermittently in HEAT mode.	The compressor and indoor fan stop intermittently if room temperature exceeds a setting temperature in order to protect the compressor from overheated air in a HEAT mode.
7	Indoor fan and outdoor fan stop operation intermittently in a HEAT mode.	The compressor operates in a reverse cycle to remove exterior ice in a HEAT mode, and indoor fan and outdoor fan do not operate intermittently for within 20% of the total heater operation.
8	The compressor stops intermittently in a COOL mode or DRY mode, and fan speed of the indoor unit decreases.	The compressor stops intermittently or the fan speed of the indoor unit decreases to prevent inside/outside air frozen depending on the inside/outside air temperature.

### 4-3-1 Wiring checking function



This product is prohibited one indoor unit installation. Don't use pipe checking operation and Auto Addressing Mode when one indoor unit is installed.

- ◆ Switch the system on and wait for code "E 99" to appear on the display of the external unit (this requires approximately 60 seconds \*\*).
- ◆ As soon as code "E 99" displays, press once the red button (K1) shown on the figure on the side of the page:



If the quantity of indoor units connected is lower than maximum connectable to outdoor unit, the rotary switch SW01 has to be positioned, in order to select a number equal to indoor units' quantity you connected.

- ◆ After the operations described above have been performed, the system starts in Cooling or Heating mode, depending on the external ambient temperature. After a few minutes (from a minimum of 3 to 5 minutes for the internal unit), the system stops automatically, completing the self-test and addressing procedure. "E 99" appears on the display of the external unit.
- ◆ 20 seconds after the display of "E 99" (that confirms the correct execution of the procedure), the following codes (if four indoor units are connected) display in sequence on the display of the external unit:

Display 1	Display 2	Description
00	00	The outdoor unit is communication correctly together the indoor unit connected to refrigerant pipe A.
01	00	The outdoor unit is communication correctly together the indoor unit connected to refrigerant pipe B.
02	00	The outdoor unit is communication correctly together the indoor unit connected to refrigerant pipe C.
03	00	The outdoor unit is communication correctly together the indoor unit connected to refrigerant pipe D.

**At this point it is possible to start the internal units in the desired mode**

- » If "E 99" doesn't display, the procedure has failed and it is therefore necessary to read ALL the operator's manual before repeating the operating described in steps 1-2-3-4.

AJ020JCJ2CH/AJ024JCJ3CH

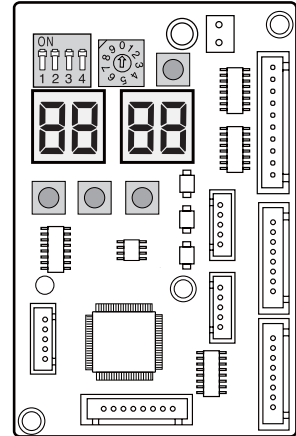

Display of the external unit

AJ036JCJ5CH

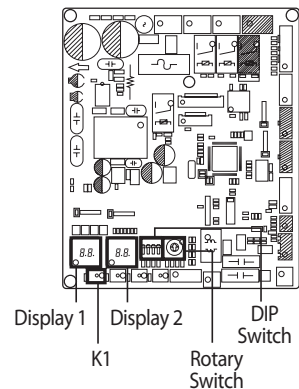

Display 1    Display 2    DIP Switch  
K1    Rotary Switch

※ During the initial 60 seconds, display 1 shows in sequence: 00 → 01 → 02 → ... 15 → 00...

## 4-3-2 Without wiring checking function

- Step 1** Review all the following elements in the installation:
- ◆ Installation site strength
  - ◆ Piping connection tightness to detect any gas leakage
  - ◆ Connection wiring
  - ◆ Heat-resistant insulation of the piping
  - ◆ Drainage
  - ◆ Earthing wire connection

- Step 2** **IMPORTANT!**  
 Before selecting switch turn off the system power supply  
 Advise control we are going to proceed with manual addressing as follow:

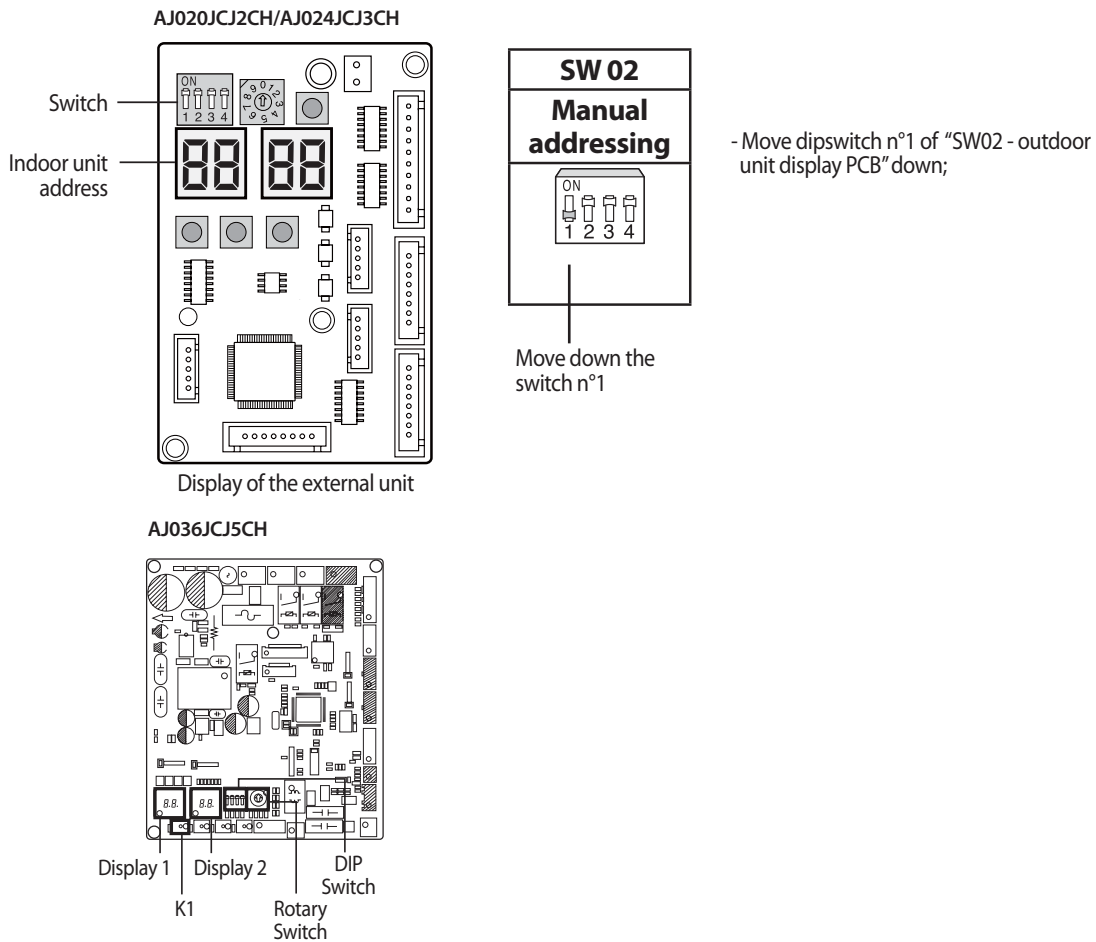

- Step 3** Follow of indication reported into table below for indoor unit addressing

- Step 4** Turn on the system power supply and waiting for 60 seconds after establishing communication between outdoor and indoor units.  
 During this phase, the left display of outdoor unit display PCB "DIS01" will count fom 00--01--02 to 15. Established communication the left display will count sequentially:  
 00--communication with indoor unit A;  
 01--communication with indoor unit B;  
 02--communication with indoor unit C;  
 03--communication with indoor unit D;

※ In case of Manual address mode,you can do pipe check operation for check whether you connect the pipes correctly or not. But you need set indoor address switch yourselves.

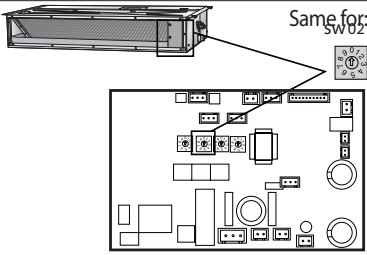

TYPE	PICTURE	MODEL	TO SET ADDRESSING MANUALLY BY ROTARY SWITCH "SW02"
SLIM DUCT		AJ009JNLDCH AJ012JNLDCH AJ018JNLDCH	

**ROTARY SWITCH "SW02" POSITION ACCORDING TO REFRIGERANT CIRCUIT CONNECTED ( 0=A; 1=B; 2=C; 3=D )**

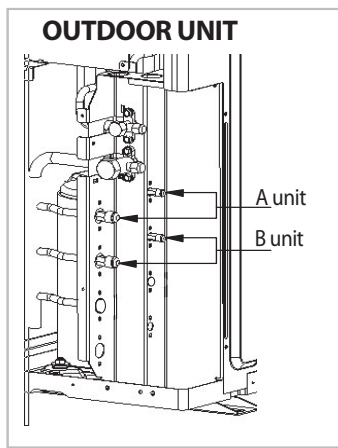

AJ020JCJ2CH

Indoor Unit  
SW02

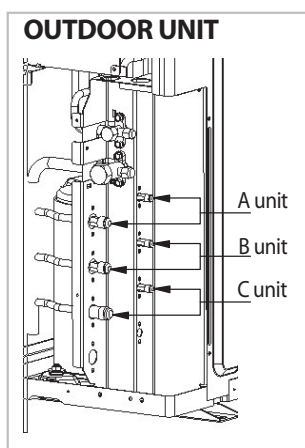

AJ024JCJ3CH

Indoor Unit  
SW02



**INSTALLATION TEST MODE (with all indoor units functioning)**

Please do cool mode try-run or heat mode try run.  
 Cool mode try-run : Push the [K2] button three times.  
 Heat mode try-run : Push the [K2] button once.

After 12 minutes of stationary condition check each indoor unit air treatment:  
 Cooling mode (indoor unit check) --> Inlet air temp. - Outlet air temp: From 10°K to 12°K ( indicative delta T)  
 Heating mode (indoor unit check) --> Outlet air temp. - Inlet air temp: From 11°K to 14°K (indicative delta T)  
 In heating mode, the indoor fan motor can remain off to avoid cold air blown into conditioned space.

## 4-4 Checking and Testing operations

It could take maximum 60 minutes to operate for the protection of the compressor, if the outdoor temperature is below -5°C.

### Ampere Limit Setting & Changing Procedure



- ◆ Do not adjust the "Ampere Limit Switch", if it's not necessary : before modifying it, evaluate the total number of electric and electronics loads consumption and use "Ampere limits switch" just as emergency solution or in case the system is anyway oversized compared to real thermal load needed.
- ◆ "Ampere Limit Switch" is initially set to the default value (table below).
- ◆ "Ampere Limit Switch" is on the PCB of outdoor unit.
- ◆ Contact the authorized service technician or dealer for setting and changing the "Ampere Limit Switch".
- ◆ Before changing the "Ampere Limit Switch", turn off the main power of the system.

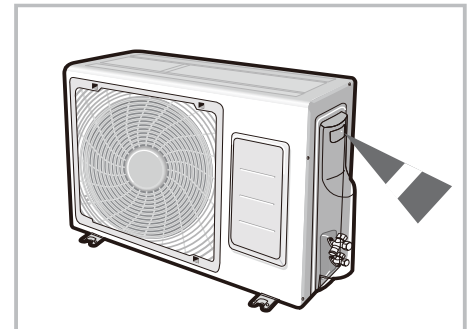

※ The designs and shape are subject to change according to the model.

AJ020JCJ2CH/AJ024JCJ3CH

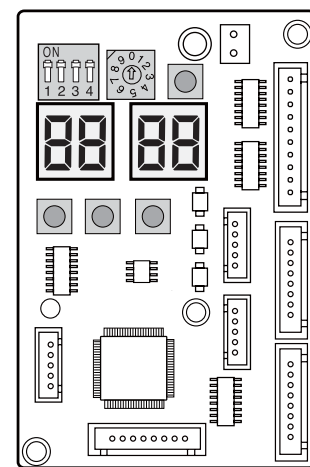

Display of the external unit

AJ036JCJ5CH

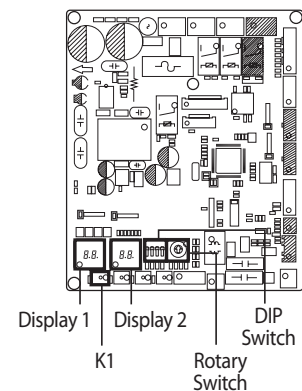

			Switch Selection		
AJ020JCJ2CH	AJ024JCJ3CH	AJ036JCJ5CH	Switch	3	4
14.0A (Default)	16.6A (Default)	23.0A (Default)	 (OFF)	ON	ON
13.0A	14.0A	20.0A	 (OFF)	ON	OFF
10.0A	11.0A	18.0A	 (OFF)	OFF	ON
8.5A	10.0A	16.0A	 (OFF)	OFF	OFF

To complete the installation, perform the following checks and tests to ensure that the air conditioner is operating correctly.





**1. Review all the following elements in the installation:**

- Installation site strength
- Piping connection tightness not to leak any gas
- Connection wiring
- Heat-resistant insulation of the piping
- Drainage
- Earthing wire connection
- Setting number of the indoor unit installed (Outdoor unit SW)
- Setting SW02 for addressing mode (AUTO or MANUAL)
- Address number on each indoor unit (Manual addressing mode)
- Correct operation for pipe checking connection (follow the step below)
- If the auto addressing, refer to next page.
- If the manual addressing, please do cool mode try-run or heat mode try-run.(refer to below)

**■ Settings of PCB Display of the Outdoor unit**

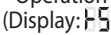
**◆ Key Options of PCB Display**

- K1 : pipe checking operation button    - K2 : Function button
- K3 : Reset button                                - K4 : View mode change button

Key / Push	K1	K2	K3	K4
1	Pipe Checking Operation (Display:  )	Heat Mode Try run (Display:  )	Reset	View mode change
2	-	Refrigerant Charging (Display:  )		
3	-	Cool Mode Try run (Display:  )		
4	-	Pump down (Display:  )		

AJ020JCJ2CH/AJ024JCJ3CH

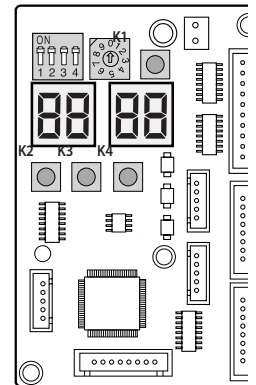

Display of the external unit

※ During the initial 60 seconds, display 1 shows in sequence: 00 → 01 → 02 → ...15 → 00...

**◆ K4 View mode Display changes**

Push	Display Explanation	Push	Display Explanation
0	Present Compressor Frequency	8	Discharge temperature
1	Target Compressor Frequency	9	OLP temperature
2	Order Compressor Frequency	10	Condenser temperature
3	EEV0 current step	11	Outdoor temperature
4	EEV1 current step	12	Running current
5	EEV2 current step	13	Target Discharge temperature
6	EEV3 current step3	14	Total capacity of the indoor units
7	Fan RPM (H: high, L: low, Blank: off)	15	Safety Control (just For Service Technician)

AJ036JCJ5CH

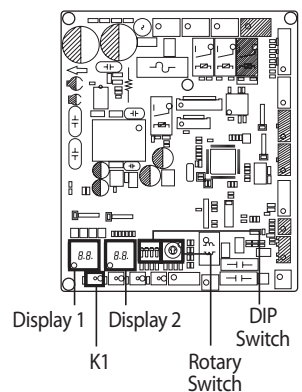

※ The EEV 2 and EEV 3 of AJ020JCJ2CH model is always displayed as blank

※ The EEV 3 of AJ024JCJ3CH model is always displayed as blank

## 2. Apply the power to the outdoor unit.

Outdoor unit will try to communicate the number of indoor units specified by SW01 on outdoor display PCB.

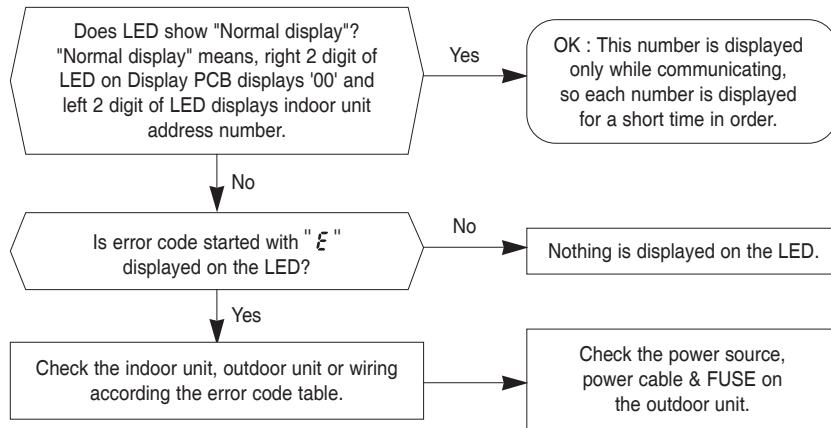

### ■ Pipe Checking Operation (Auto Addressing Mode)

Automated checking of pipe connection (Auto addressing option)

- Turn on the outdoor unit and wait for one minute.
- During these 60 seconds,the left display DIS01 will show sequentially 00-01-02-03-...15-00.
- E199 is showed on the display PCB of outdoor unit.
- It means you didn 't do "Pipe check operation"
- Push [K1 ] button on the display PCB of outdoor unit once, then begins to start "Pipe check operation" with displaying as below.

		Button [K1] 1 times	
Display	DIS 01	DIS 02	
			
[DIS 01 ] is flickering on the setting time.			
Time duration	Outdoor Temperature		
	0°C or more	less than 0°C	
	(Cool mode) 5min~10min	(Heat mode) 20min~50min	

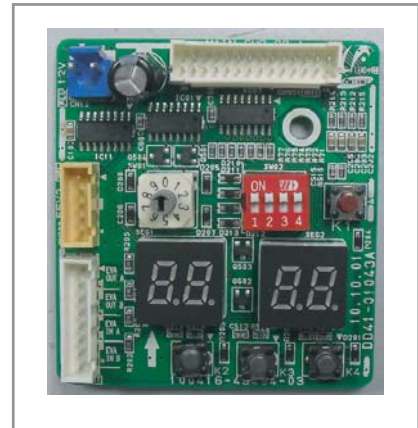

- \* Expected time of 4 indoor units installation.
  - [DIS02 ] shows the indoor unit under searching.
  - It could take more time depending on the indoor and outdoor temperature.
  - After completeing pipe check operation,it shows "" on the display PCB.
  - The left display DIS01 will show sequentially the following message:
    - 00 -Established communication with indoor unit "A";
    - 01 -Established communication with indoor unit "B";
    - 02 -Established communication with indoor unit "C";
    - 03 -Established communication with indoor unit "D";
    - 00 -Established communication with indoor unit "A"...

• Function of **Step 3**

Mode	Function
Auto Addressing	Checking the connection & addressing
Manual Addressing	Checking the connection only

- If the auto addressing does not work according to the indoor unit capacity, model or installation condition,apply the manual addressing.

\* When SW01 set "0"on Auto address mode,it means you install the maximum number of indoor unit.

1) Installation ID Unit Number=MAX Installation ID Unit Number of OD Unit.

⇒Don't need set SW01.

2) Installation ID Unit Number<MAX Installation ID Unit Number of OD Unit.

⇒Pls set SW01 as the number of which you install the indoor unit.

\* On Manual address mode,you must set SW01 as the number of which you install the indoor unit.

- This mode is for finding the combination between indoor unit and each valve on the outdoor unit. Because refrigerant flow is controlled with EEV in the outdoor, controller should know which EEV will control which indoor unit.

- Once "PIPE CHECK MODE" is done normally, each indoor unit will remember the given address number by the outdoor unit and no need to do this checking. But in case of listed below, PIPE CHECK MODE should be done again.

- Re-install the system (ie.house moving)
- Remove indoor unit, Add new indoor unit, Change indoor PCB for repair.
- Mode change from "manual addressing" to "auto addressing"

- On this mode the controller will ignore the manual address number set on the rotary switch on the indoor PCB.

- To confirm the indoor address number assigned by this mode, use "TESTMODE" and the address number will be displayed on the LED display on the indoor unit.

● If Error code is displayed on indoor or outdoor LED, check as follows;

- Manual address setting

Contents		
Q1	Turn on the system. But outdoor units PCB displayed E201 or E101 Error code.	
	Check point	Remarks
Step 1	Check to Number of indoor unit's SW01.	Outdoor PCB SW01
Step 2	Check to power cable to indoor units. Check to communication cable indoor units.	Wire connect

Contents		
Q2	Turn on the system. But outdoor units PCB displayed E203 Error code.	
	Check point	Remarks
Guidance	Outdoor communication error between the outdoor main PCB and sub PCB.	Outdoor PCB SW01
Step 1	Check to sub PCB wire and replace it.	Wire connect

Contents	
Q3	Turn on the indoor units. But indoor unit displayed E121/122/123/154 Error code.
Error code	Explanation
E121	Indoor unit room temperature sensor error (open/short)
E122	Indoor unit heat exchanger in temperature sensor error (open/short)
E123	Indoor unit heat exchanger out temperature sensor error (open/short)
E154	Indoor unite fan error
Guidance	Please, all units turn off and check to indoor unit's PCB and wire connection. E121/122/123 error detected, replace related sensor.

Contents	
Q4	Turn on the system. But indoor unit displayed E162/163 Error code.
Error code	Explanation
E162	Indoor unit EEPROM Error.
E163	Indoor unit EEPROM Option Error.
Guidance	Please, all units turn off and follow guidance. E163 : Please reset indoor Option code. If you don't know about that, replace indoor unit PCB which is related. E162 : Please replace indoor unit PCB which is related.

Contents	
Q5	Turn on the system. But outdoor unit displayed E221/237/251/320 Error code.
Error code	Explanation
E221	Outside temperature sensor error (open/short)
E237	Indoor unit heat exchanger in temperature sensor error (open/short)
E251	Condenser temperature sensor error (open/short)
E251	Compressor Discharge temperature sensor error (open/short)
E320	Compressor OLP sensor error (open/short)
Guidance	Please, The System turn off and replace sensor which is related.

Contents		
Q6	Indoor units address SW setting correct, but outdoor unit's PCB displayed E201 Error Code.	
	Check point	Remarks
Analysis	Indoor unit's sub PCB address SW or sub PCB is connected by mistake.	
Step 1	Check to indoor unit's sub PCB wire connecting condition.(misconnecting or Sub PCB is out of order)	Indoor Sub PCB
Step 2	Address setting mode change to auto address setting.	
Step 3	Following auto address setting steps.	
Guidance	Manual Address setting is Option in FJM PLUS A. But we solved problem like this situation, with auto address setting.	

#### - Auto address setting

Contents		
Q1	When the pipe checking operation is finished, outdoor sub PCB display E190 Error code.	
	Check point	Remarks
Analysis	Outdoor unit fails to search indoor units or to check indoor address.	The pipe checking operation
Step 1	Whether The gas and liquid pipes are crossed with each other, check to connecting.	Pipe connecting
Step 2	Check to outdoor unit's EEV coil being connected in proper location.	EEV Coil
Step 3	Check to indoor unit's sensor being connected in proper location.	Indoor sensor
Guidance	During the pipe checking operation , system check temperature change of indoor Heat exchanger.In case, indoor sensor defect, EEV coil connector detach, malfunction of EEV, Leakage of Refrigerant, and etc can make this case.	

#### - Address setting another case

Contents		
Q1	When the system installation is finished, outdoor unit's PCB display E202 Error code.	
	Check point	Remarks
Analysis	This problem is caused by outdoor unit's communication part trouble or indoor units power and communication line trouble.	The pipe checking operation
Step 1	Check to connect outdoor unit and indoor units cable.	Pipe connecting
Step 2	Replace outdoor unit's ass'y control or indoor unit's ass'y control.	EEV Coil
Guidance	Basically, This error caused by communication between Indoor Units and Outdoor Unit. First of all, check the all communication connection and PCB's status.	



**- Operation Error**

Contents							
Q1	While using cooling or heating, indoor units display E161 Error code						
	<table border="1"> <thead> <tr> <th>Check point</th> <th>Remarks</th> </tr> </thead> <tbody> <tr> <td></td> <td>This problem is caused by user's fault. User's simultaneously operate 2 more indoor units in the same time cooling and heating mode.</td> </tr> <tr> <td></td> <td>FJM is operate by just cooling or heating mode only. (Only, HR system can operate cooling and heating mode simultaneously in the same time) Outdoor unit will be operate by first received signal, another operation signal is not applied system.</td> </tr> </tbody> </table>	Check point	Remarks		This problem is caused by user's fault. User's simultaneously operate 2 more indoor units in the same time cooling and heating mode.		FJM is operate by just cooling or heating mode only. (Only, HR system can operate cooling and heating mode simultaneously in the same time) Outdoor unit will be operate by first received signal, another operation signal is not applied system.
Check point	Remarks						
	This problem is caused by user's fault. User's simultaneously operate 2 more indoor units in the same time cooling and heating mode.						
	FJM is operate by just cooling or heating mode only. (Only, HR system can operate cooling and heating mode simultaneously in the same time) Outdoor unit will be operate by first received signal, another operation signal is not applied system.						

Contents											
Q2	While using cooling or heating, System turn off and display E416 Error code.										
	<table border="1"> <thead> <tr> <th>Check point</th> <th>Remarks</th> </tr> </thead> <tbody> <tr> <td></td> <td>E416 is outdoor unit high discharge temperature safety control Error code. After System restart automatically until 3 times, system stop and display this error. System can be operated by remote controller signal and K3(reset) key input.</td> </tr> <tr> <td>Step 1</td> <td>Check outdoor units installation environment. (air flow blocking, the halation of another outdoor air flow)</td> </tr> <tr> <td>Step 2</td> <td>Check refrigerant leakage.</td> </tr> <tr> <td>Step 3</td> <td>Check outdoor EEV operation.</td> </tr> </tbody> </table>	Check point	Remarks		E416 is outdoor unit high discharge temperature safety control Error code. After System restart automatically until 3 times, system stop and display this error. System can be operated by remote controller signal and K3(reset) key input.	Step 1	Check outdoor units installation environment. (air flow blocking, the halation of another outdoor air flow)	Step 2	Check refrigerant leakage.	Step 3	Check outdoor EEV operation.
Check point	Remarks										
	E416 is outdoor unit high discharge temperature safety control Error code. After System restart automatically until 3 times, system stop and display this error. System can be operated by remote controller signal and K3(reset) key input.										
Step 1	Check outdoor units installation environment. (air flow blocking, the halation of another outdoor air flow)										
Step 2	Check refrigerant leakage.										
Step 3	Check outdoor EEV operation.										

Contents											
Q3	While using cooling or heating, System Turn off and display E458 Error code										
	<table border="1"> <thead> <tr> <th>Check point</th> <th>Remarks</th> </tr> </thead> <tbody> <tr> <td></td> <td>E458 Error is related with outdoor unit fan Error. Especially, If system have a some problem in fan, in heating mode , it will be happened. And In auto address setting, without pipe checking operation must be happened it.</td> </tr> <tr> <td>Step 1</td> <td>Check to outdoor fan operation.</td> </tr> <tr> <td>Step 2</td> <td>If outdoor fan operation is clear, start to pipe checking operation.</td> </tr> <tr> <td>Guidance</td> <td>When Auto address setting is finished without pipe checking operation, in heating mode, outdoor unit refrigerant distribution control is malfunction. It make our system to confuse it's condition. But, basically this error code is concerned about fan error.</td> </tr> </tbody> </table>	Check point	Remarks		E458 Error is related with outdoor unit fan Error. Especially, If system have a some problem in fan, in heating mode , it will be happened. And In auto address setting, without pipe checking operation must be happened it.	Step 1	Check to outdoor fan operation.	Step 2	If outdoor fan operation is clear, start to pipe checking operation.	Guidance	When Auto address setting is finished without pipe checking operation, in heating mode, outdoor unit refrigerant distribution control is malfunction. It make our system to confuse it's condition. But, basically this error code is concerned about fan error.
Check point	Remarks										
	E458 Error is related with outdoor unit fan Error. Especially, If system have a some problem in fan, in heating mode , it will be happened. And In auto address setting, without pipe checking operation must be happened it.										
Step 1	Check to outdoor fan operation.										
Step 2	If outdoor fan operation is clear, start to pipe checking operation.										
Guidance	When Auto address setting is finished without pipe checking operation, in heating mode, outdoor unit refrigerant distribution control is malfunction. It make our system to confuse it's condition. But, basically this error code is concerned about fan error.										

Contents									
Q4	While using cooling mode, outdoor unit turn off and display E401 Error code.								
	<table border="1"> <thead> <tr> <th>Check point</th> <th>Remarks</th> </tr> </thead> <tbody> <tr> <td></td> <td>This is caused by protection mode behavior. This is indoor Evaporator Freezing protection mode.</td> </tr> <tr> <td>Step 1</td> <td>Please, check indoor unit, whether inlet or outlet grill is closed.</td> </tr> <tr> <td>Step 2</td> <td>Please, check indoor unit, whether indoor fan is working.</td> </tr> </tbody> </table>	Check point	Remarks		This is caused by protection mode behavior. This is indoor Evaporator Freezing protection mode.	Step 1	Please, check indoor unit, whether inlet or outlet grill is closed.	Step 2	Please, check indoor unit, whether indoor fan is working.
Check point	Remarks								
	This is caused by protection mode behavior. This is indoor Evaporator Freezing protection mode.								
Step 1	Please, check indoor unit, whether inlet or outlet grill is closed.								
Step 2	Please, check indoor unit, whether indoor fan is working.								

Contents					
Q5	When system start in cooling mode, System don't operate and display E441 Error code				
	<table border="1"> <thead> <tr> <th>Check point</th> <th>Remarks</th> </tr> </thead> <tbody> <tr> <td></td> <td></td> </tr> </tbody> </table>	Check point	Remarks		
Check point	Remarks				
Analysis	FJM PLUS is able to operate by -10°C But we admit that minimum Cooling temperature is by -5°C Please, Remember cooling operation range.				

Contents					
Q6	While using heating, outdoor unit turn off and display E404 Error code.				
	<table border="1"> <thead> <tr> <th>Check point</th> <th>Remarks</th> </tr> </thead> <tbody> <tr> <td></td> <td></td> </tr> </tbody> </table>	Check point	Remarks		
Check point	Remarks				
Analysis	Heating overload safety mode make this situation. After System restart automatically until 3 times, System display this error code and stop. System can operate by remote controller input signal or K3(reset) key input.				
Step 1	Check indoor units air flow.				
Step 2	Check outdoor unit air flow and installation (outdoor air flow blocking & over charging)				

Contents					
Q7	When system start in Heating mode, System don't operate and display E440 Error code.				
	<table border="1"> <thead> <tr> <th>Check point</th> <th>Remarks</th> </tr> </thead> <tbody> <tr> <td></td> <td></td> </tr> </tbody> </table>	Check point	Remarks		
Check point	Remarks				
Analysis	FJM PLUS is able to operate up to 30°C But we admit that Maximum Heating temperature is up to 24°C Please, Remember Heating operation range.				

#### - Try-run Check Error

Contents					
Q1	While the system is working try-run mode, system turn off and display E128 / 129 / 246 / 261 / 419 / 422 / 554 Error code.				
	<table border="1"> <thead> <tr> <th>Check point</th> <th>Remarks</th> </tr> </thead> <tbody> <tr> <td></td> <td></td> </tr> </tbody> </table>	Check point	Remarks		
Check point	Remarks				
Analysis	These Error codes only apply with Try-run mode, in case of system have some defect as result of try-run operation. * Refer to self-detection algorithm (Check Error Code meaning and check it out)				

## 4-5 Fault Diagnosis by Symptom

### 4-5-1 Indoor

#### 4-5-1-1 Indoor temperature sensor (open/short)

Indoor unit display	X (Operation) X (Defrost) ● (Timer) X (Fan) X (Filter)
Wire remote controller display	E121
Symptom	Error of Room sensor in the indoor unit (Open/Short)
Failure	Short or leakage of the Room sensor

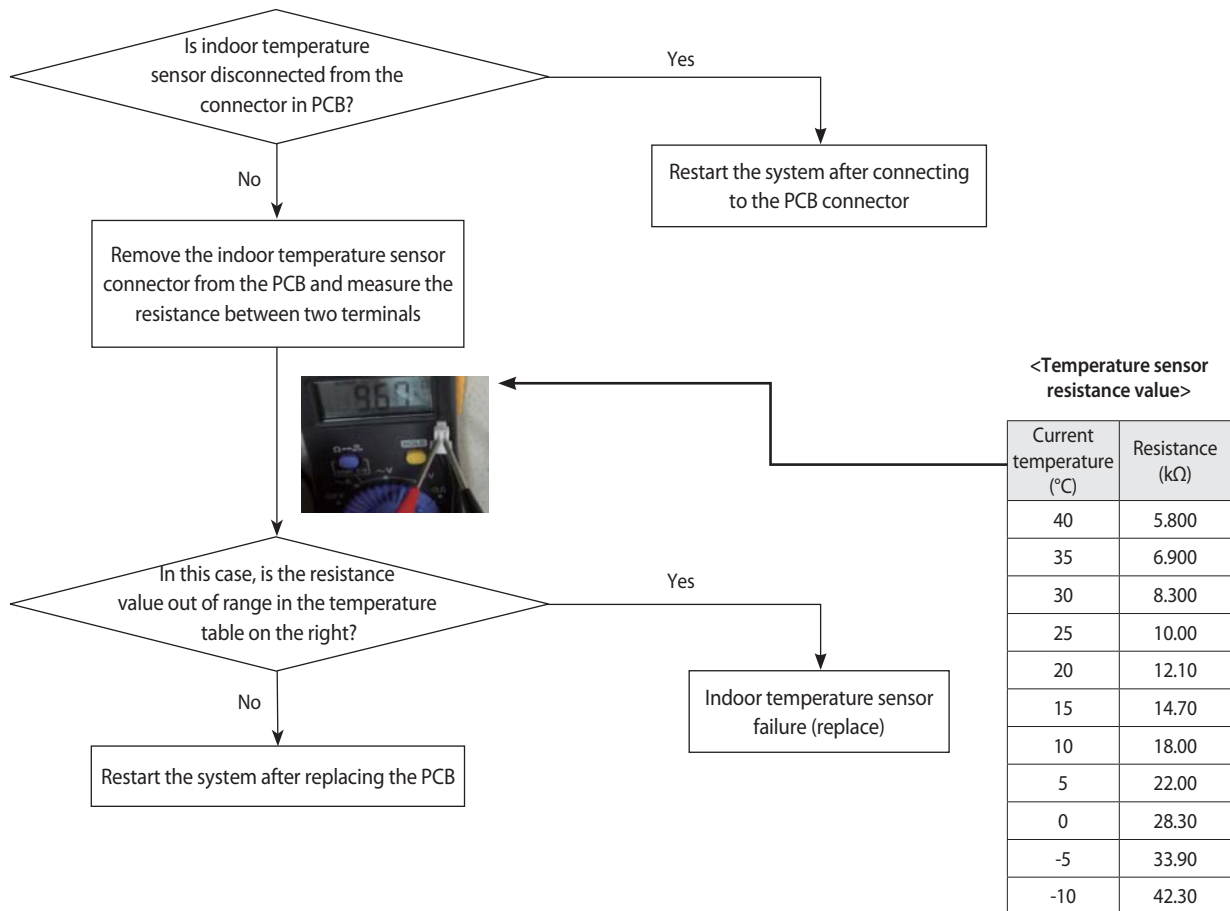

### 4-5-1-2 Indoor FAN Error ( BLDC MOTOR MODEL )

Indoor unit display	X (Operation) X (Defrost) X (Timer) ● (Fan) X (Filter)
Wire remote controller display	E154
Symptom	Error of Fan motor in the indoor unit
Failure	Fan sensor

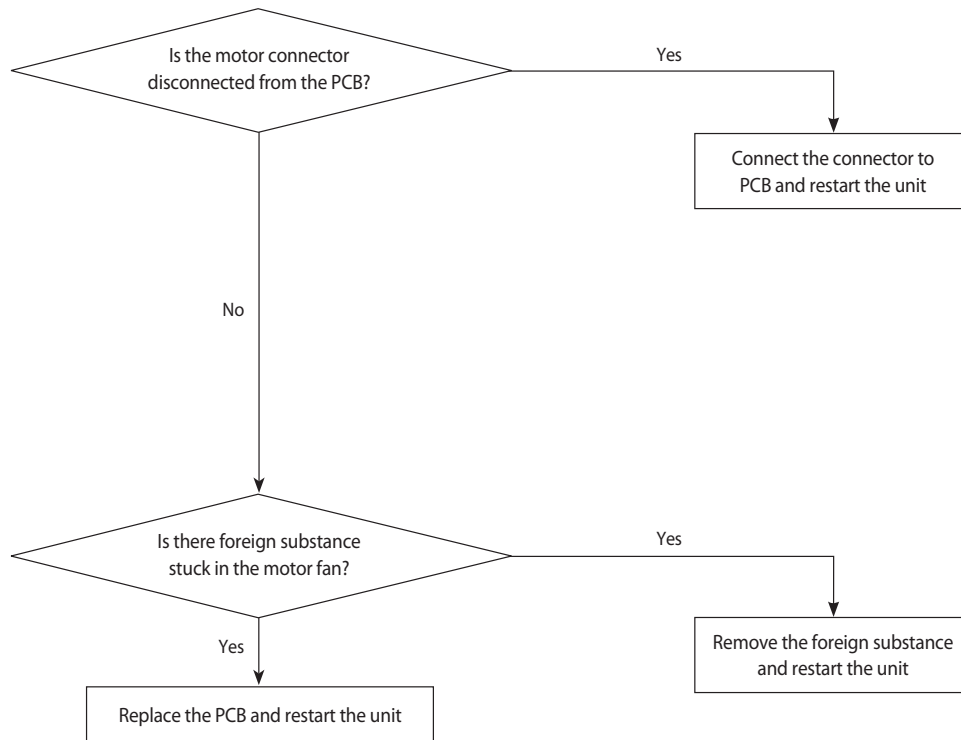

### 4-5-1-3 Communication error after finishing Tracking

<b>Indoor unit display</b>	X (Operation) X (Defrost) ● (Timer) ● (Fan) X (Filter)
<b>Symptom</b>	Communication error between the indoor and outdoor unit for two minutes
<b>Failure</b>	Communication error between the indoor unit and outdoor unit

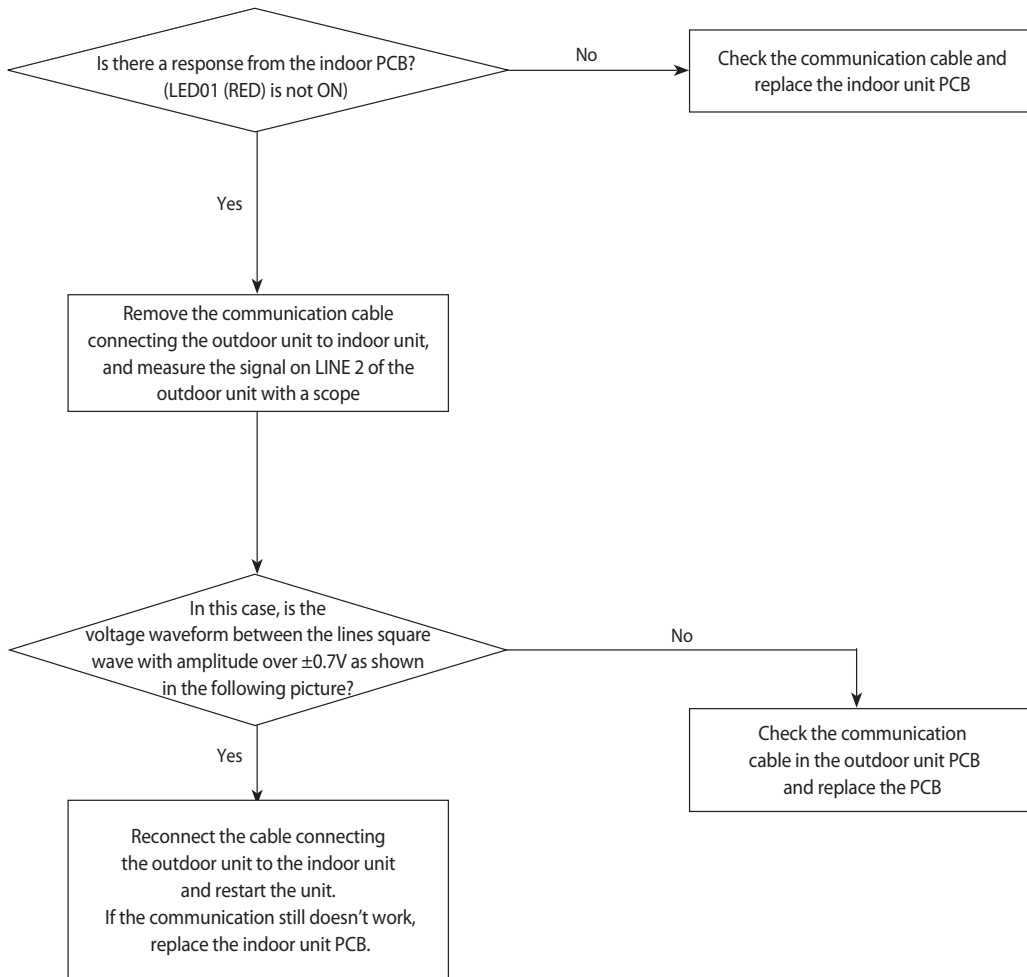

CASE 1. Normal condition

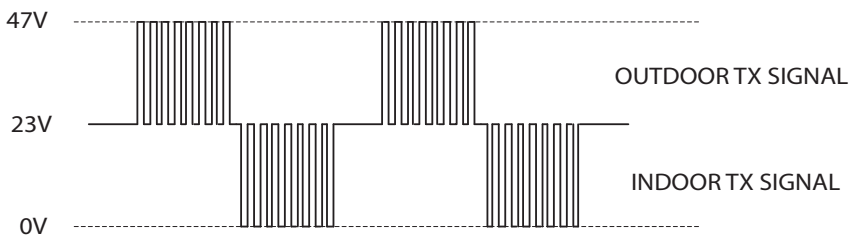

CASE 2. Abnormal condition

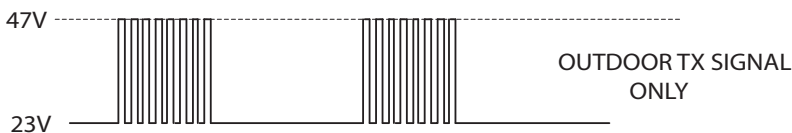

#### 4-5-1-4 EEPROM circuit failure

Indoor unit display	● (Operation) ● (Defrost) ● (Timer) X (Filter)
Symptom	EEPROM circuit failure
Failure	EEPROM component failure, EEPROM circuit parts missing/damaged/soldering failure

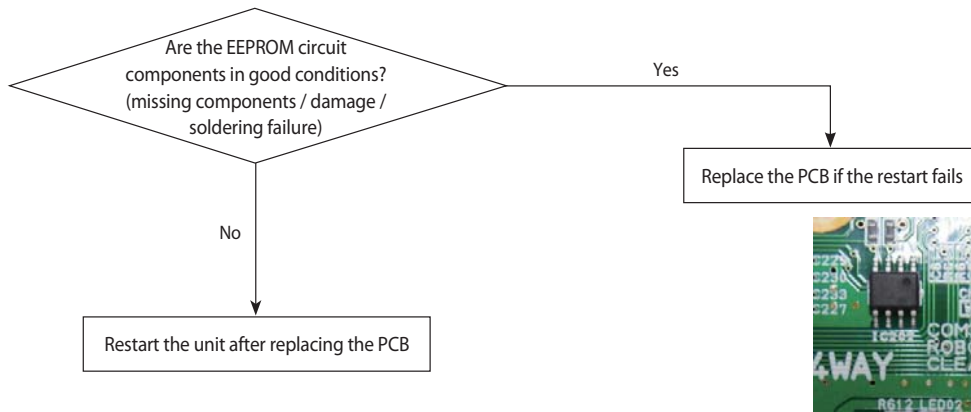

## 4-5-2 Outdoor unit is not powered on – Initial diagnosis(1phase)

### 1. Check items

- 1) Is the power supply voltage 220V?
- 2) Is the AC power connected correctly?
- 3) Are the LEDs in the main PCB and inverter PCB of the outdoor unit ON?
- 4) Is the input power voltage of the indoor unit 220V?
- 5) Is the wired remote controller connected correctly?

### 2. Check procedure

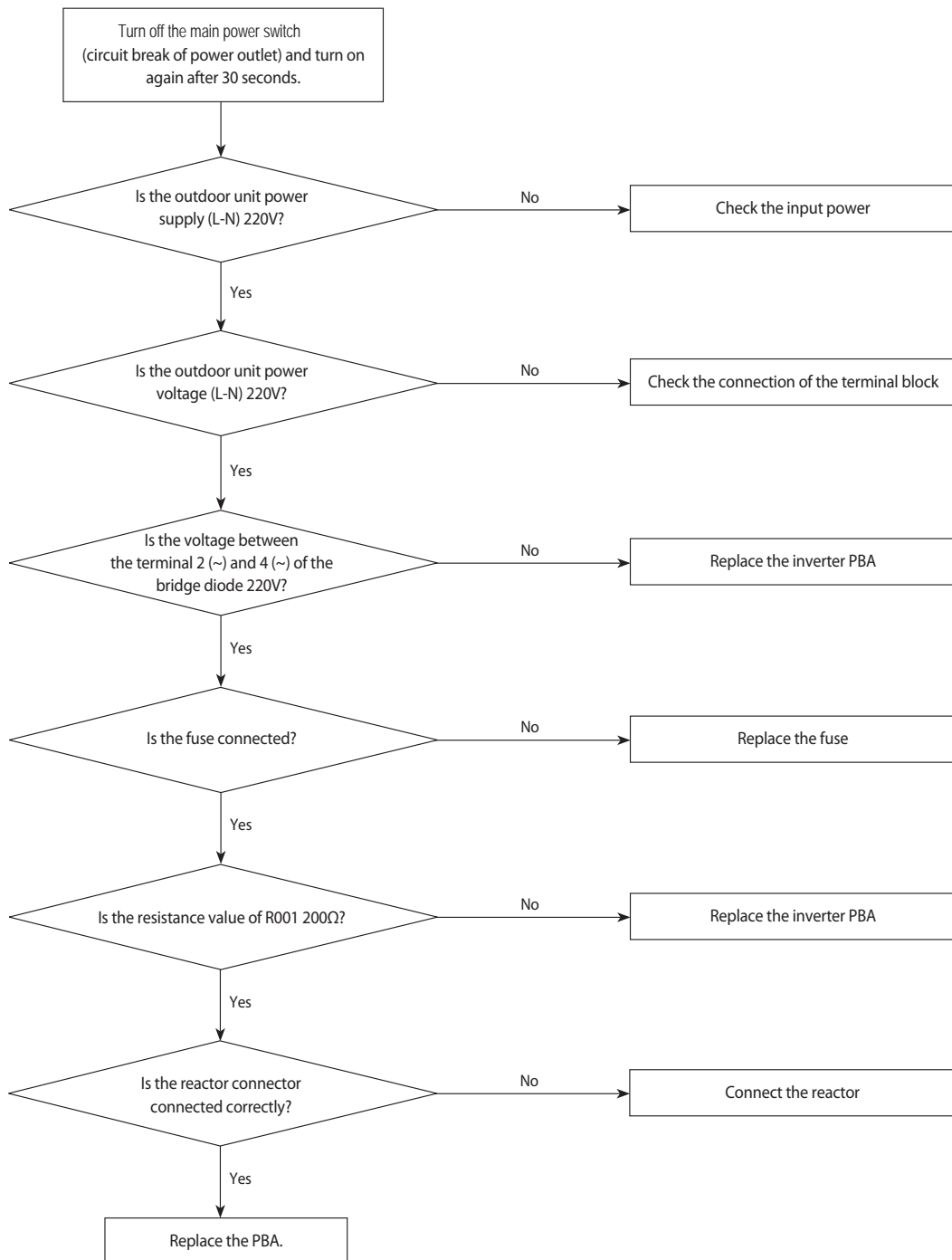



### 4-5-3 Outdoor unit fan error

#### 1. Check items

- 1) Are the input voltage and power connection correct?
- 2) Is the motor connecting wire connected to the outdoor unit PCB correctly?
- 3) Are the indoor/outdoor fuses connected?
- 4) Are there any obstacles near the motor or propeller?
- 5) Is the motor driver out of order?
- 6) AJ020/024 Model check CN901 , AJ036 Model Check CN 90

#### 2. Check procedure

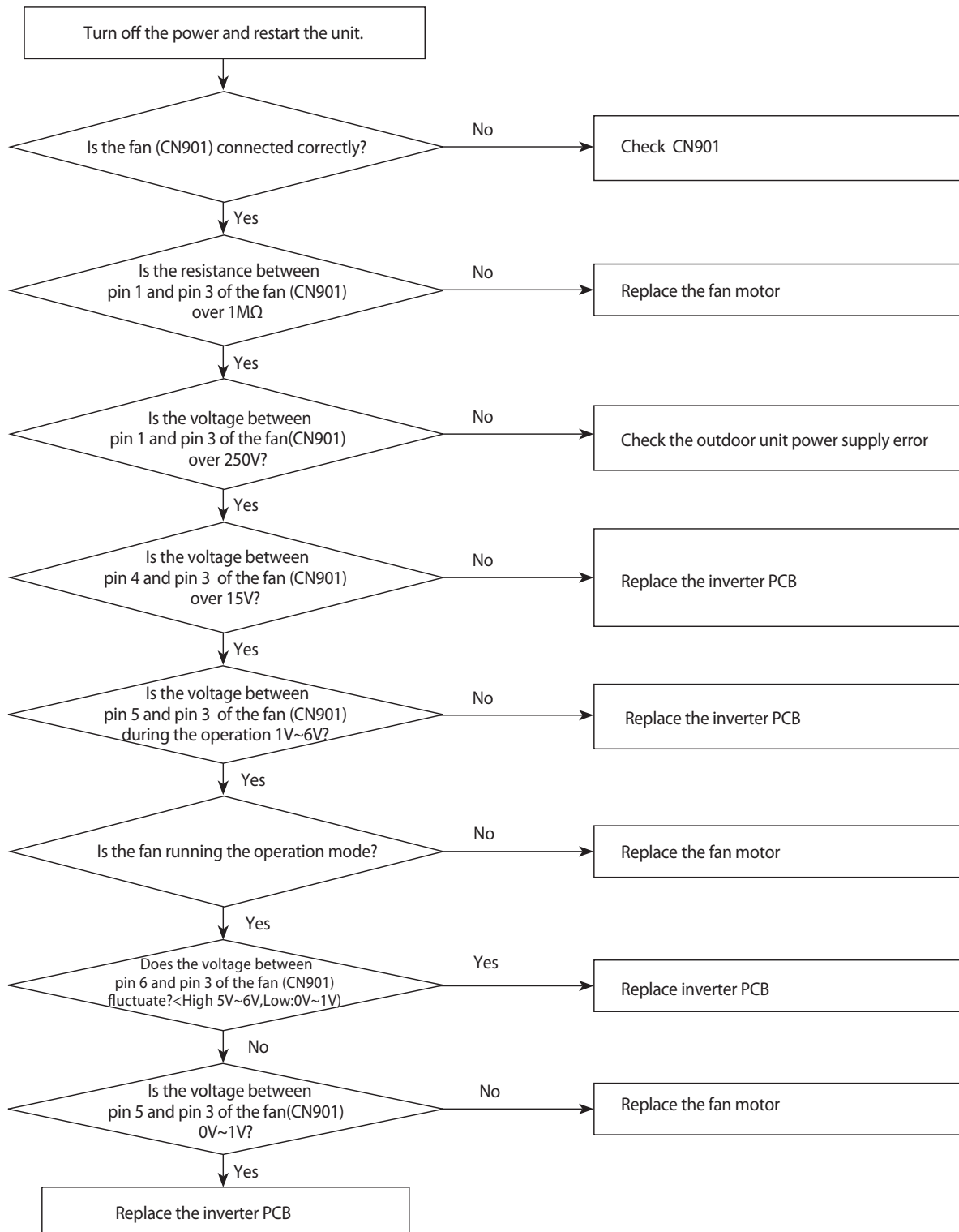

#### 4-5-4 Compressor startup error, Compressor Lock error, Compressor rotation error.

##### 1. Check items

- 1) Are the power supply and compressor connecting wires connected correctly?
- 2) Is the inter-phase resistance of the compressor normal?

##### 2. Check procedure

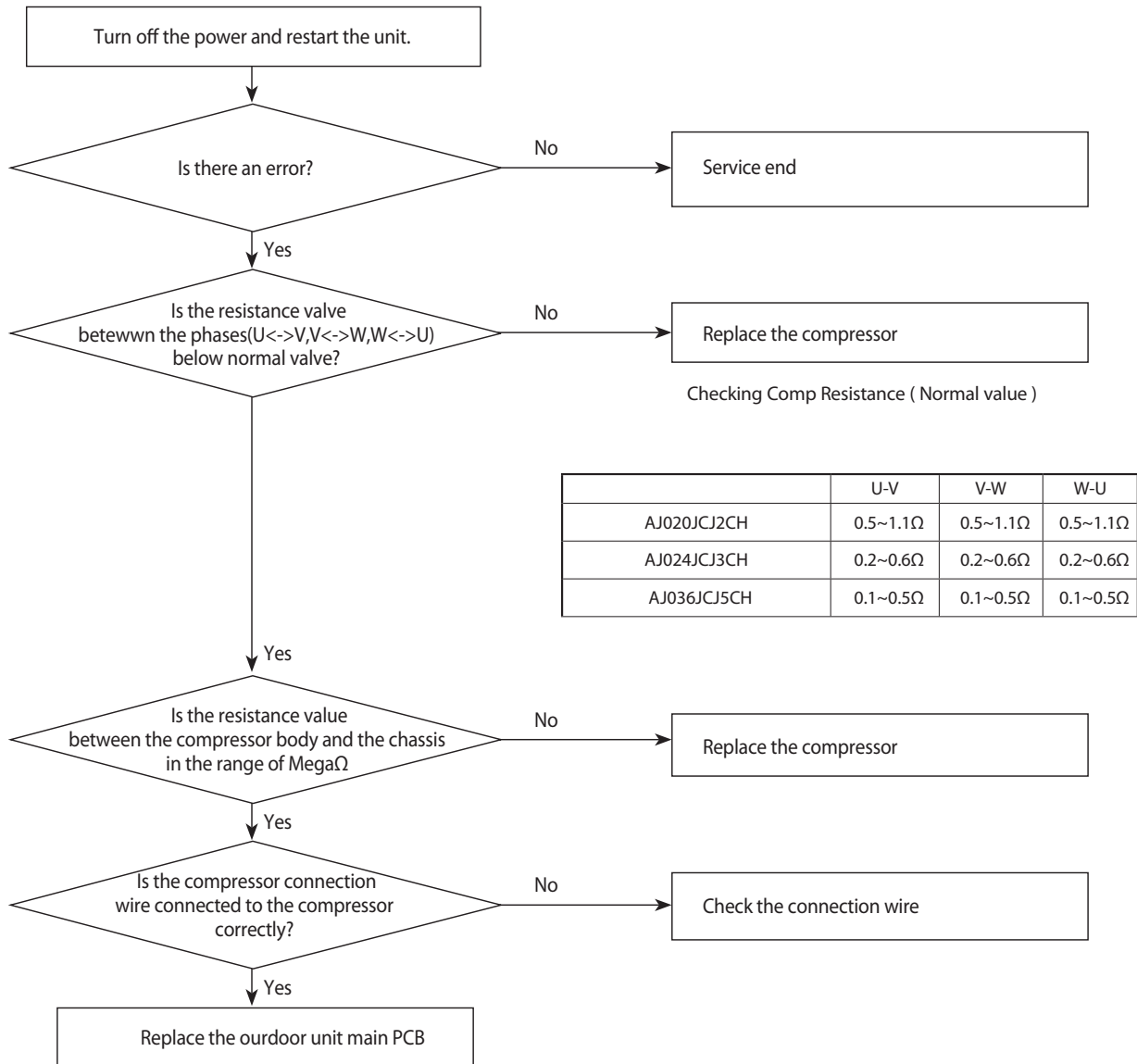

### 4-5-5 IPM Over Current error

#### 1. Check items

- 1) Is the coolant changed?
- 2) Is the compressor running normally?
- 3) Is the compressor connected correctly?
- 4) Are there any obstacles near the indoor and outdoor units?

#### 2. Check procedure

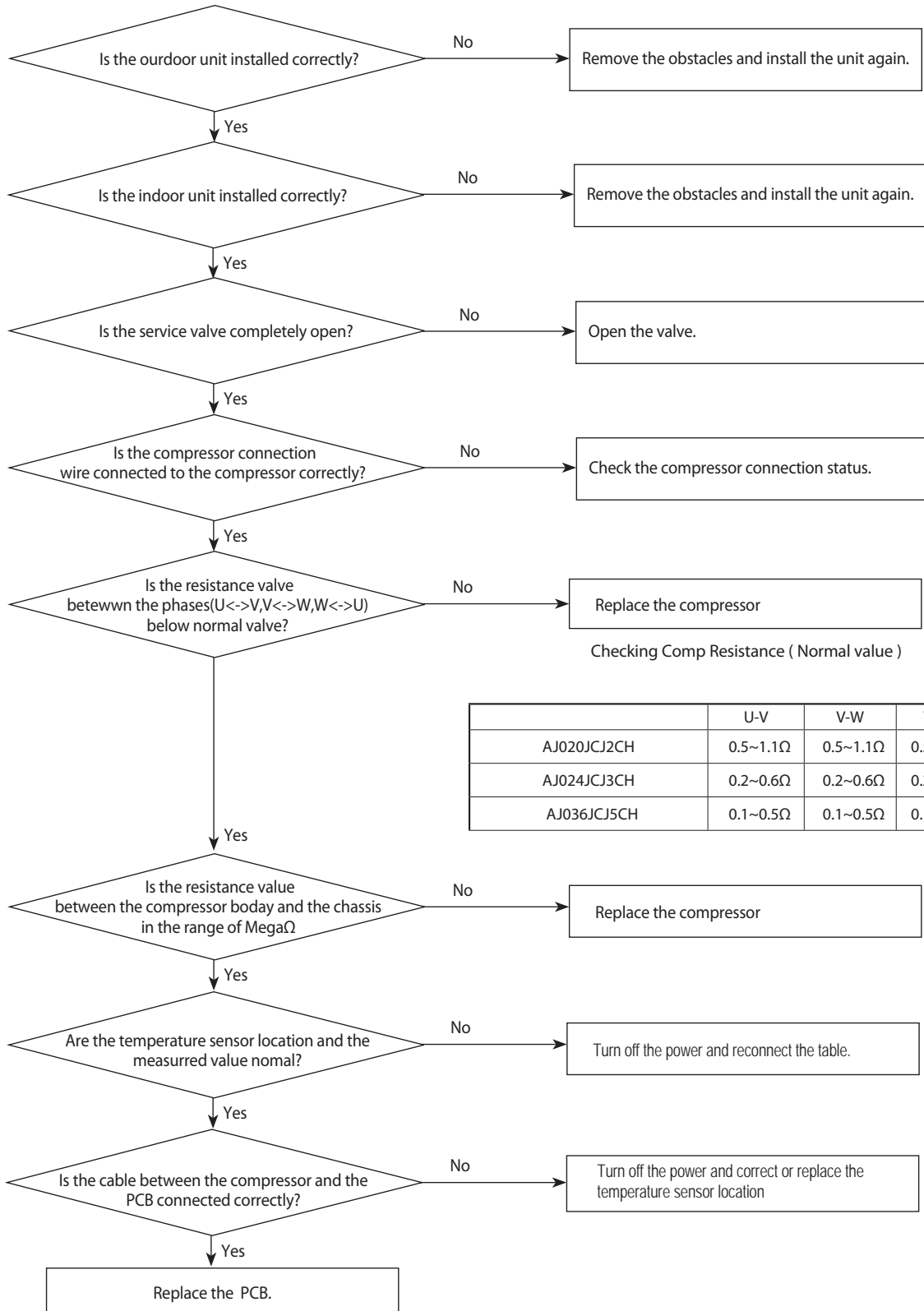

Checking Comp Resistance ( Normal value )

	U-V	V-W	W-U
AJ020JCJ2CH	0.5~1.1Ω	0.5~1.1Ω	0.5~1.1Ω
AJ024JCJ3CH	0.2~0.6Ω	0.2~0.6Ω	0.2~0.6Ω
AJ036JCJ5CH	0.1~0.5Ω	0.1~0.5Ω	0.1~0.5Ω

### 4-5-6 Checking Temperature sensor

In case of a sensor in outdoor unit, temperature can be monitored with "VIEW MODE".

Press K4 key on the outdoor display PCB for several time to change the display to sensor temperature value. Left 1 digit of the LED is data index and Right 2 digits are the value.

Index	Value	Remark
8	Discharge sensor temperature	The unit is degree C
9	OLP sensor temperature	
A	Condenser sensor temperature	
B	Outdoor sensor temperature	

#### 4-5-6-1 Outdoor Discharge/OLP temperature sensor error

##### 1. Check Items:

- 1) Is the sensor connected correctly?
- 2) Is the sensor placed correctly?
- 3) Does the both terminal of sensor satisfy the resistance value in accordance with temperature?
- 4) Is the resistance value of sensor connection pull-up correct?

##### 2. Troubleshooting procedure

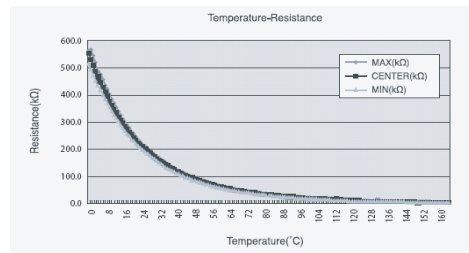
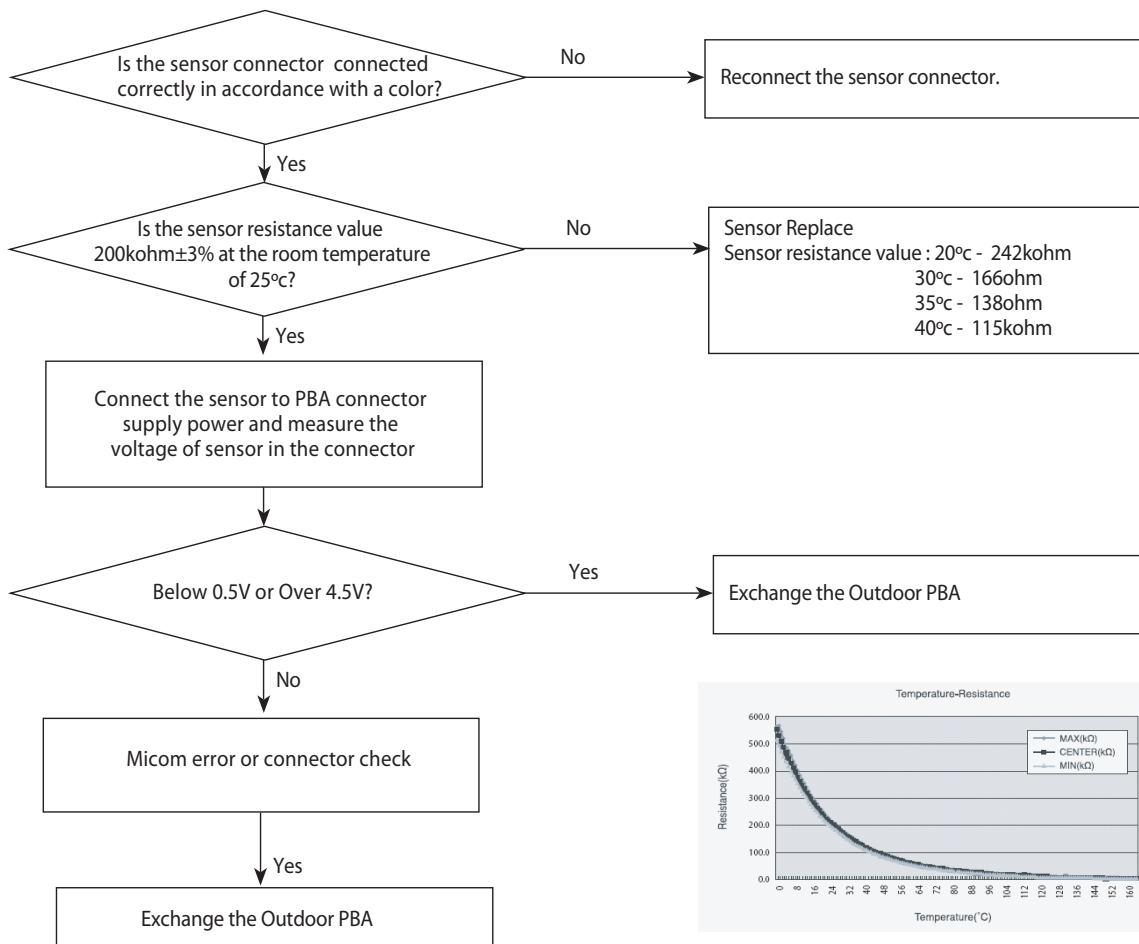

### 4-5-6-2 Outdoor out / cond temperature sensor error

1. Check Items:
  - 1) Is the sensor connected correctly?
  - 2) Is the sensor placed correctly?
  - 3) Does the both terminal of sensor satisfy the resistance value in accordance with temperature?
  - 4) Is the resistance value of sensor connection pull-up correct?
2. Troubleshooting procedure

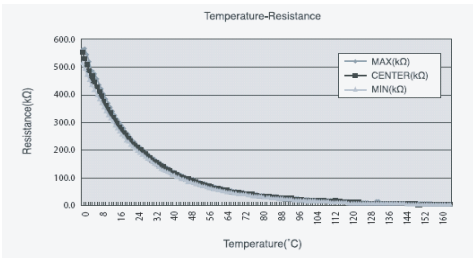
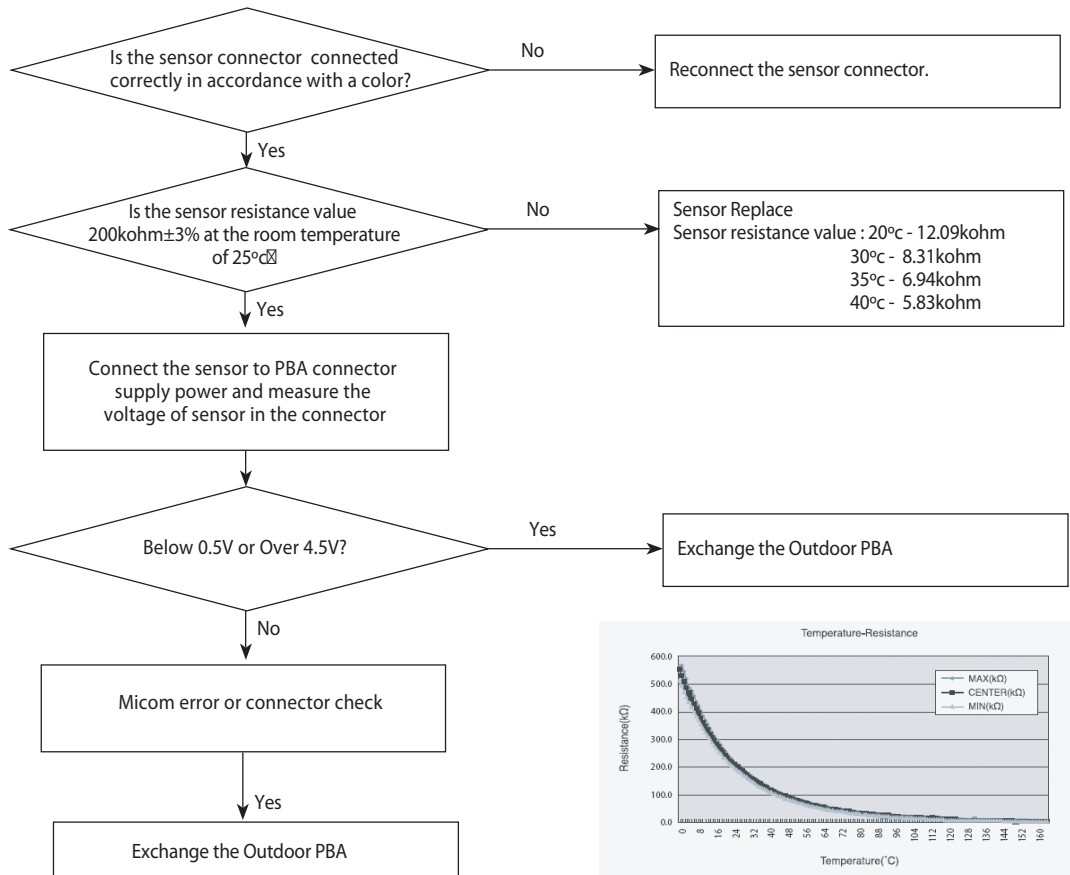

### 4-5-7 Checking EEV

Current EEV step value can monitored with "VIEW MODE"

Press K4 key on the outdoor display PCB for several time to change the display to current EEV value.

Left 1 digit of the LED is data index and Right 3 digits is the value.

Index	Value		Remark
3	EEV-A step	AJ020JCJ2CH	The step value range is between Zero and 480.
4	EEV-B step		
5	EEV-C step		

## 4-6 PCB Inspection

### 4-6-1 Cautions for Part Replacement

1. The human body carries much static electricity. Before touching a part for repair, replacement or the similar purpose, be sure to touch a grounded metallic portion by hand to let the static electricity go through the metallic portion to the earth. Especially when handling any micro computer or IC, carefully remove such static electricity before touching them.
2. When repairing any part on a work bench, be sure to place an insulative sheet on the bench and always keep the sheet surface neat without any metal fragments. If any such fragment touches a part, a secondary trouble will possibly be caused in the part.
3. Before replacing any parts, be sure to turn off the power supply. If such replacement is done with the power supply kept on, an electric shock, short circuit or destruction of a part may result.
4. During replacement or repair of a part, carefully handle it : The printed circuit board has fine lead wires (jumper wires) and glass-made parts (diode) on its substrate. So if a circuit board is roughly handled, such lead wires and parts will be easily broken or damaged by bending or shock.
5. When soldering the lead wires of any new part, be sure to polish them using an emery paper or the like before soldering them. Since the lead wires of any new part are covered with an oxide film, solder cannot adhere to the lead wires if not polished.
6. When soldering any part, care should be exercised not to apply any high-wattage soldering iron to the part for a long time. Some parts are of so low a heat resistance that they may be broken or have the properties changed if a soldering iron is so applied (Otherwise, the pattern may possibly be separated and raised).
7. The heat of the soldering iron should be transferred to the entire object to be soldered. If the solder pieces are not well fused due to insufficient transfer of the heat from the soldering iron, no satisfactory electrical continuity can be assured even if the soldered objects appear well connected to each other.
8. The solder used should be limited to a minimum. If excessive solder is used, it will cause inter-pattern contact, which may cause malfunction of the circuit.
9. Although some part of the PCB surface are coated with coating material for protection from dust and dirt, soldering is also available to the coating part. Because this coating is thin and is weak for soldering heat. But coating material remaining on the solder part should be cleaned up before soldering a new component to prevent the solder part from becoming bad conduction.
10. After replacing a faulty PCB by a new one, the same address setting must be applied to the new PCB. (refer to the page 4-19 ~ page 4-24)
11. When connected to an outdoor unit manufactured after June, 2011, a new option code is not needed.

### 4-6-2 Procedure

The parts should be replaced in the following procedure.

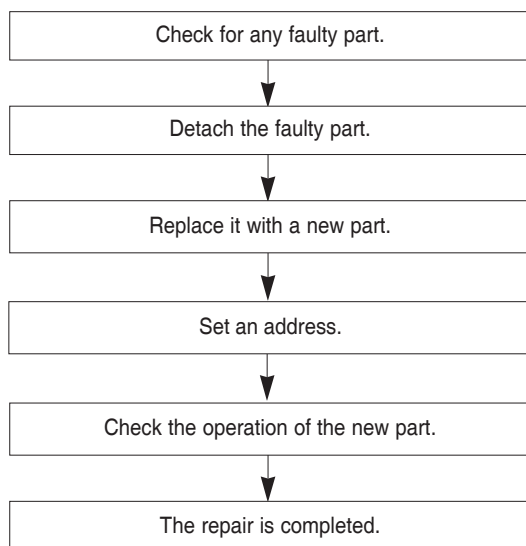

# 5. PCB Diagram and Parts list

## 5-1. Indoor Unit

### ■ AJ009JNLDCH/AJ012JNLDCH/AJ018JNLDCH

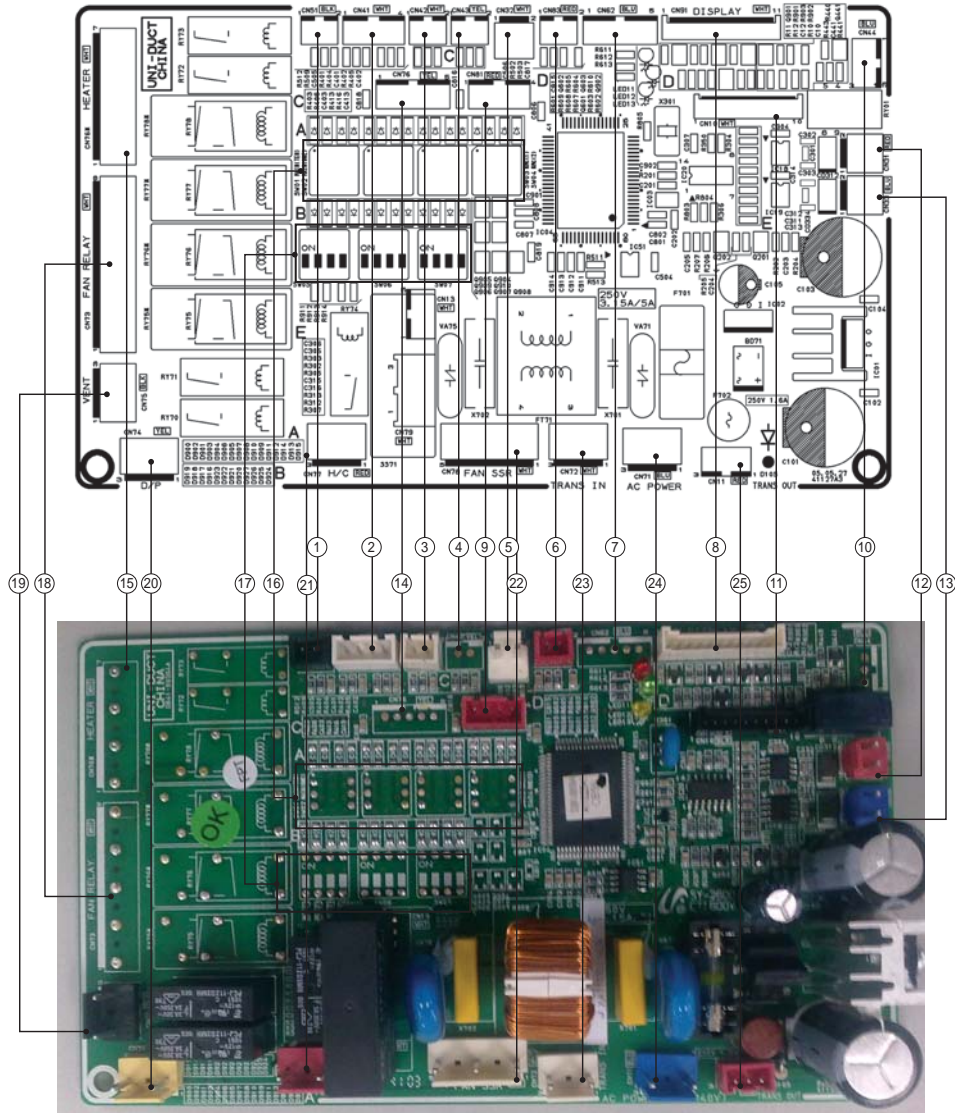

①	Floating S/W : SMW250-02(BLK)	⑬	Wired Remote Controller Communication : YW396-02(BLU)
②	Indoor Pipe In Temperature Sensor : SMW250-04(WHT)	⑭	Option Load Connector : SMW250-05(YEL)
	Indoor Room Temperature Sensor : SMW250-04(WHT)	⑮	Heater : YW39607AV(WHT)
③	Indoor Pipe Out : SMW250-02(WHT)	⑯	Indoor Address S/W
	Temperature Sensor : SMW250-02(WHT)	⑰	Indoor Option S/W
④	Heater Discharge : SMW250-02(YEL)	⑱	Indoor Fan(TAP) : YW396-09AV(WHT)
	Temperature Sensor : SMW250-02(YEL)	⑲	Ventilator : YW396-03AV(BLK)
⑤	Wired Remote Controller Power : YW396-02(WHT)	⑳	Drain Pump : YW396-03AV(YEL)
⑥	External Control(S/W Part) : SMW250-02(RED)	㉑	Hot Coil : YW396-03AV(RED)
⑦	EEV : SMW250-05(BLU) : SMW250-05(BLU)	㉒	Indoor Fan(SSR) : YW396-03AV(RED)
⑧	Display : SMW200-11(WHT) : SMW200-11(WHT)	⑳	Power : YW396-03AV(WHT)
⑨	External Control(Display Part) : SMW250-04(RED)		Transformer Out : YW396-03AV(WHT)
⑩	HALL IC : SMW250-03(BLU)	㉔	Main Power In : YW396-03AV(BLU)
⑪	MICOM Download : SMW200-10(WHT)	㉕	Power : YW396-03AV(BLU)
⑫	Indoor/Outdoor Communication : YW396-02(RED)		Transformer In : SMW250-03(RED)



## ■ AJ012JNNDCH/AJ018JNNDCH

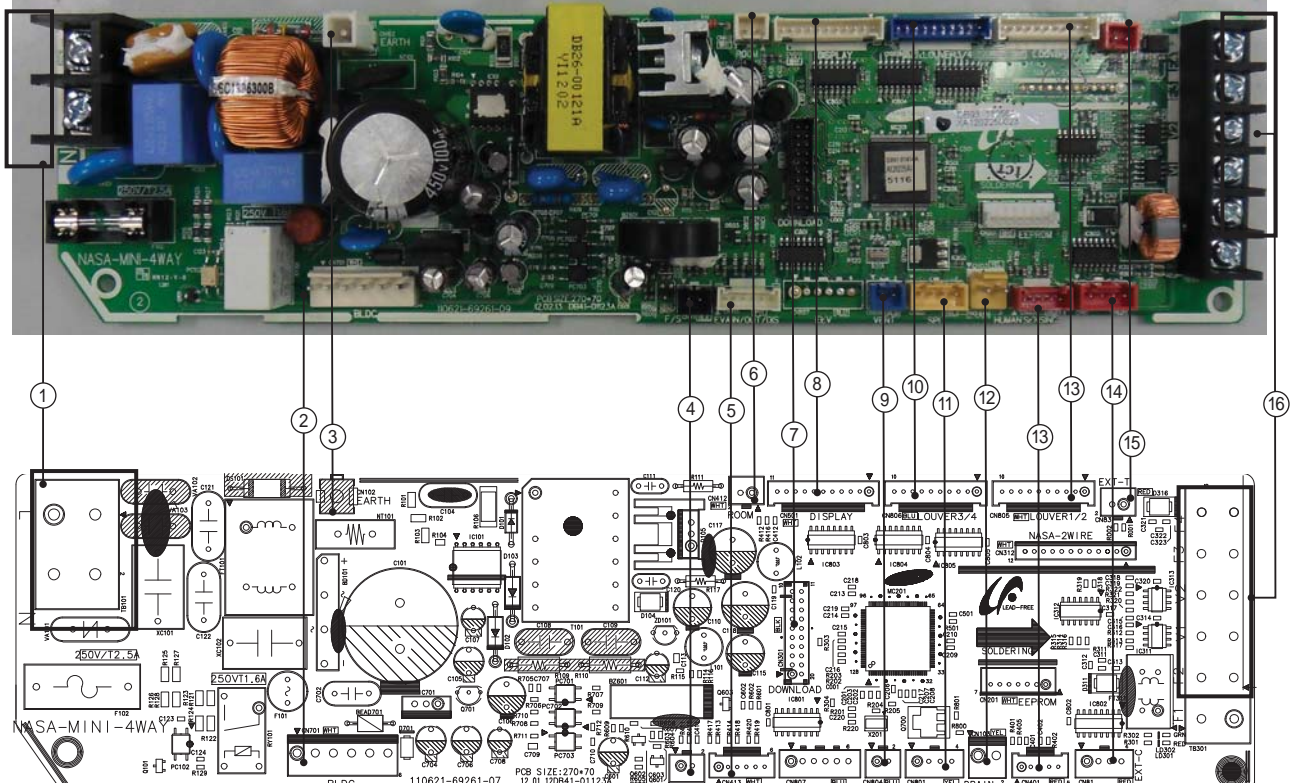

(1) Main power input 1(L):Phase L 2(N):Phase N	(2) BLDC fan 1:DC10V 2:Not used 3:AGND 4:DC15V 5:FAN PRM 6:PRM FEEDBACK	(3) Earth wire 1:GND	(4) Float switch 1:Float_SW 2:GND
(5) Eva in/out sensor 1:EVA IN temperture sensor 2,4,6:GND 3:EVA OUT temperture sensor 5:EVA discharge	(6) Room temperature 1:Room temperature sensor 2:GND	(7) S/W download S/W download	(8) Panel display 1:DC12V 2-5:LED control signal 6:REMOCON signal out 7,8:Not used 9:REMOCON_INT 10:GND 11:Vcc
(9) VENT 1:DC12V 2:VENT_OUT	(10) Panel flaps 1:DC12V 2-5: Louver control signal 6:DV12V 7-10:Louver control signal	(11) SPI 1,2:GND 3:SPI CONTROL 4:Not Used	(12) Drain Pump 1:DC12V 2:DRAOM_PUMP_OUT
(13) Human Sensor 1:DC12V 2:Com4_TXD 3:Com4_RXD 4:Human sensor reset 5:GND	(14) External 1,3:DC12V 2:Error_CHK_OUT 3:Comp_CHK_OUT	(15) External 1:EXT_CTRL 2:GND	(16) COM1,COM2,V1,V2 F3-F4: Com2 V1-V2:DC12V F1-F2:Com1

■ Panel PCB

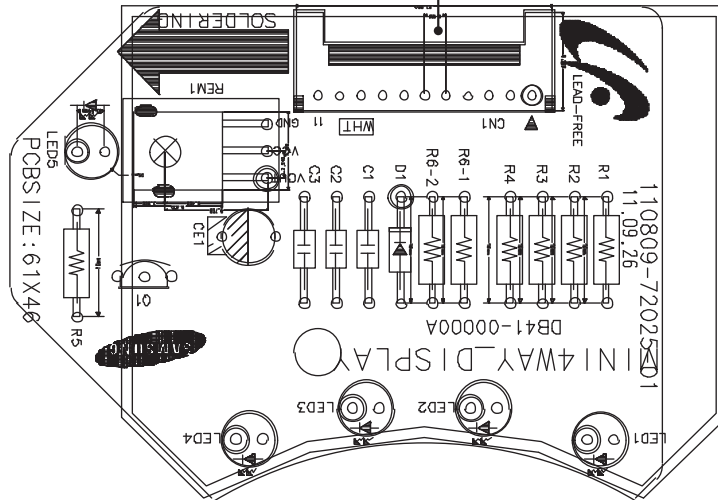
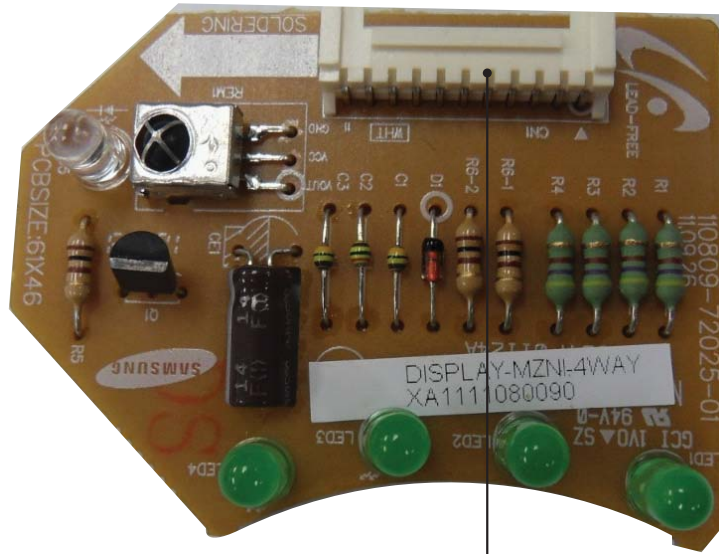

① **CN01-DISPLAY**

- #1 : DC 12V
- #2~5 : LED control signal
- #6 : Remocon signal out
- #7~8 : Not used
- #9 : Remocon signal IN
- #10: GND
- #11: DC 5V

■ AJ007JNADCH/AJ009JNADCH/AJ012JNADCH/AJ018JNADCH/AJ024JNADCH

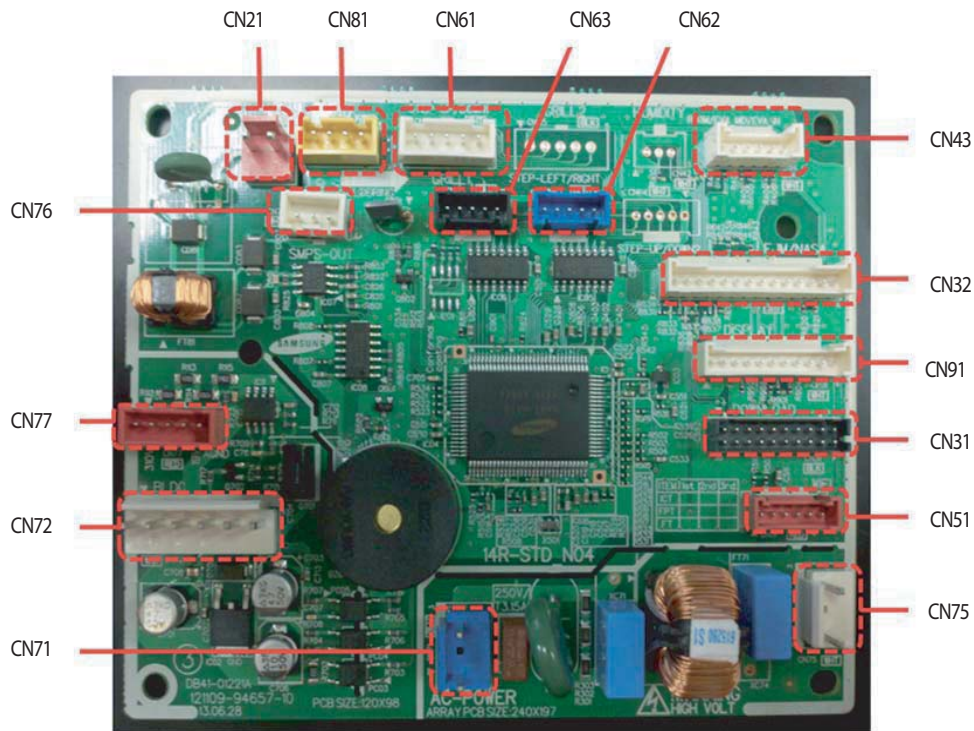

<p>① <b>CN61/CN62/CN63 - STEP MOTOR</b></p> <p>#1: DC 12V #2~#5: STEP MOTOR SIGNAL</p>	<p>② <b>CN71 - POWER IN</b></p> <p>#1,#3: AC220~240V #2: N.C</p>	<p>③ <b>CN81 - SPI</b></p> <p>#1: SPI SIGNAL #3: DC 12V</p>	<p>④ <b>CN51 - WI-FI MODULE</b></p> <p>#1: WIFI UART SIGNAL1 #2: WIFI UART SIGNAL2 #3: WIFI RESET SIGNAL #4: GND #5: DC 12V #6: N.C</p>
<p>⑤ <b>CN51 - DISPLAY</b></p> <p>#1~#11,#14,#17~#20: MICOM DOWN #12,#13,#15,#16: N.C</p>	<p>⑥ <b>CN43 - TEMPERATURE SENSOR</b></p> <p>#1,#2: ROOM SENSOR #3,#4: EVA MID SENSOR #5,#6: EVA IN SENSOR</p>	<p>⑦ <b>CN21 - COMMUNICATION</b></p> <p>#1,#2: 485 COMM SIGNAL</p>	<p>⑧ <b>CN72 - BLDC FAN MOTOR</b></p> <p>#1: DC 310~340V #2: N.C #3: AGND #4: DC 15V #5: FAN RPM #6: FAN FEEDBACK</p>
<p>⑨ <b>CN32 - FJM/NASA</b></p> <p>#1~#7,#11~#14: FJM/NASA SIGNAL #8: DC 5V #9: GND #10: DC 12V</p>	<p>⑩ <b>CN75 - SMPS POWER IN</b></p> <p>#1,#3: AC220~240V #2: N.C</p>	<p>⑪ <b>CN76 - SMPS DC OUT (12V/GND/5V)</b></p> <p>#1: DC 5V #2: GND #3: DC 12V</p>	<p>⑫ <b>CN77 - SMPS DC OUT (19V/GND/310V)</b></p> <p>#1: DC 310V~340V #2,#3: N.C #4: DC 19V~27V #5: AGND</p>
<p>⑬ <b>CN31 - DOWNLOAD</b></p> <p>DOWNLOAD</p>			

■ AJ\*\*\*NBNDCH/AA

-MAIN PCB

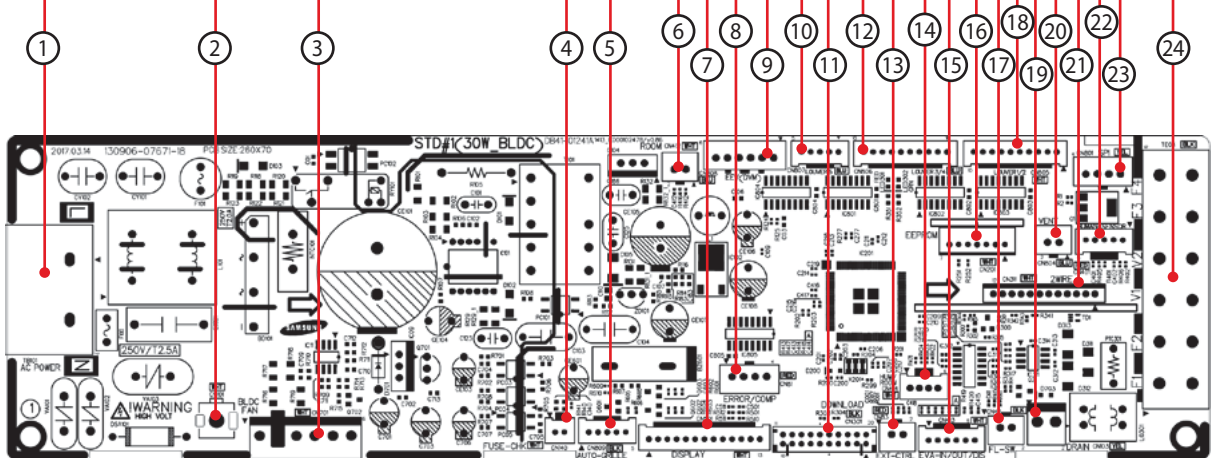
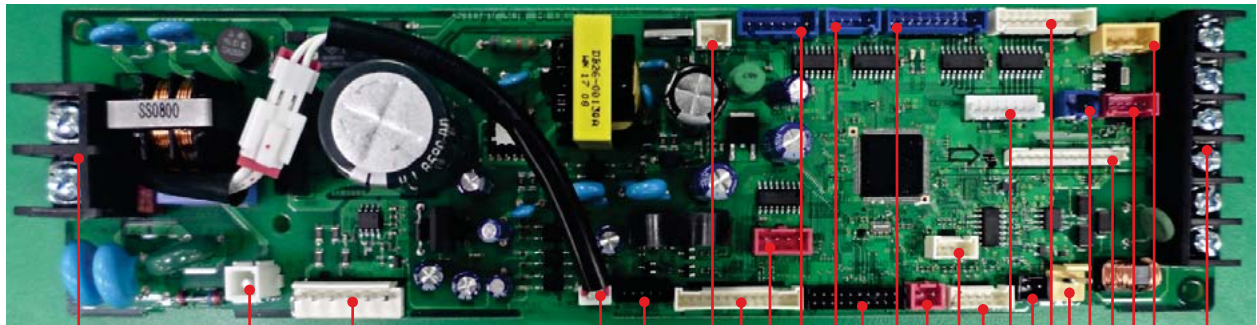

<p>① <b>TB101-AC POWER</b> #1: AC POWER (L) #2: AC POWER (N)</p>	<p>② <b>CN101-EARTH</b> #1: EARTH</p>	<p>③ <b>CN701-BLDC MOTOR</b> #1: DC310V #3: GND #4: DC15V #5: FAN RPM #6: RPM FEEDBACK</p>	<p>④ <b>CN140-FUSE CHECK</b> #1: FUSE CHECK Signal #2: GND</p>
<p>⑤ <b>CN809-AUTO GRILLE</b> #1: DC12V #4: REMOCON OUT #5: GND</p>	<p>⑥ <b>CN412-ROOM SENSOR</b> #1: ROOM SENSOR #2: GND</p>	<p>⑦ <b>CN501-DISPLAY</b> #1: DC12V #2: LED_0 #3: LED_1 #4: LED_2 #5: LED_3 #6: LED_4 #7: LED_5 #8: REMOCON OUT #9: AUTO SWITCH #10: REMOCON IN #11: GND #12: DC5V #13: GND</p>	<p>⑧ <b>CN81-COMP/ERROR MONITOR</b> #1: DC12V #2: ERROR OUT (GND) #3: DC12V #4: COMP/OPER. OUT (GND)</p>



<p>⑨ <b>CN808-EEV</b>  #1~#4: EEV SIGNAL  #5: DC12V  #6: DC12V</p>	<p>⑩ <b>CN807-LOUVER5</b>  #1 : DC12V  #2~#5: LOUVER SIGNAL</p>	<p>⑪ <b>CN301-DOWNLOAD</b></p>	<p>⑫ <b>CN806-LOUVER3/4</b>  #1 : DC12V  #2~#5: LOUVER SIGNAL  #6 : DC12V  #7~#10: LOUVER SIGNAL</p>
<p>⑬ <b>CN83-EXT CTRL</b>  #1: GND  #2: EXTERNAL CONTROL SIGNAL</p>	<p>⑭ <b>CN414-HUMIDITY SENSOR</b>  #1 : DC5V  #2 : GND  #3 : THERMISTOR SENSOR  #4 : HUMIDITY SENSOR</p>	<p>⑮ <b>CN413:THERMISTOR</b>  #1 : EVA-IN SENSOR  #2 : GND  #3 : EVA-OUT SENSOR  #4 : GND  #5 : DISCHARGE SENSOR  #6 : GND</p>	<p>⑯ <b>CN201-EEPROM</b>  #1: GND  #3: DC5V  #4: EEPROM_SELECT  #5: EEPROM_SO  #6: EEPROM_SI  #7: EEPROM_CLK</p>
<p>⑰ <b>CN411-FLOAT SWITCH</b>  #1: FLOAT SWITCH SIGNAL  #2: GND</p>	<p>⑱ <b>CN805-LOUVER1/2</b>  #1 : DC12V  #2~#5: LOUVER SIGNAL</p>	<p>⑲ <b>CN103-DRAIN PUMP</b>  #1: DRAIN PUMP (DC12V)  #2: GND</p>	<p>⑳ <b>CN804-VENTILATOR</b>  #1: DC12V  #2: VENT SIGNAL OUTPUT(GND)</p>
<p>㉑ <b>CN311-2 WIRED SUB</b></p>	<p>㉒ <b>CN401-HUMAN SENSING</b>  #1: DC12V  #2: MAIN-HUMAN SENSOR COMM(TXD)  #3: MAIN-HUMAN SENSOR COMM(RXD)  #4: GND</p>	<p>㉓ <b>CN801-SPI</b>  #1: GND  #2: GND  #3: SPI SIGNAL (DC12V)</p>	<p>㉔ <b>TE04-COMMUNICATION</b>  #1: COM1(F1)  #2: COM1(F2)  #3: V1(DC12V)  #4: V2(GND)  #5: COM2(F3)  #6: COM2(F4)</p>

■ AJ\*\*\*NBNDCH/AA  
-DISPLAY PCB

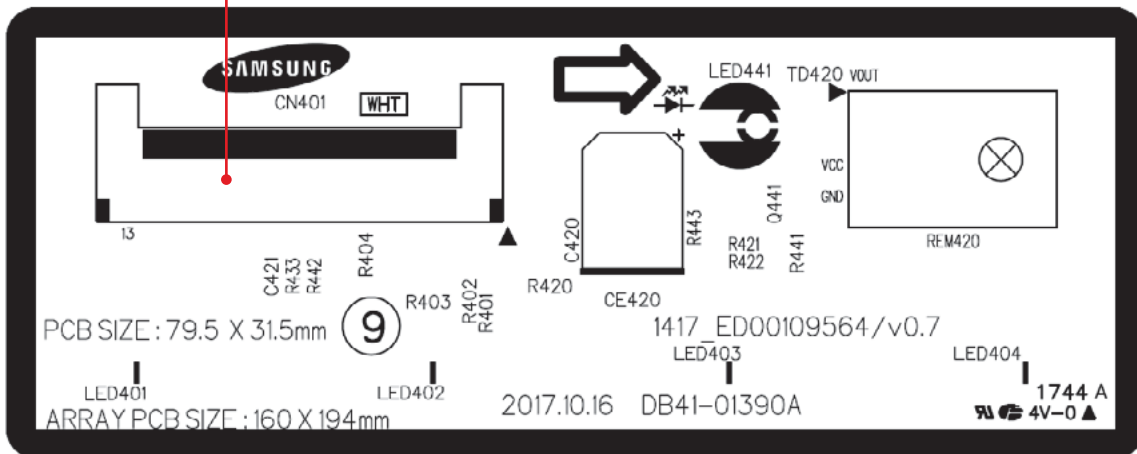
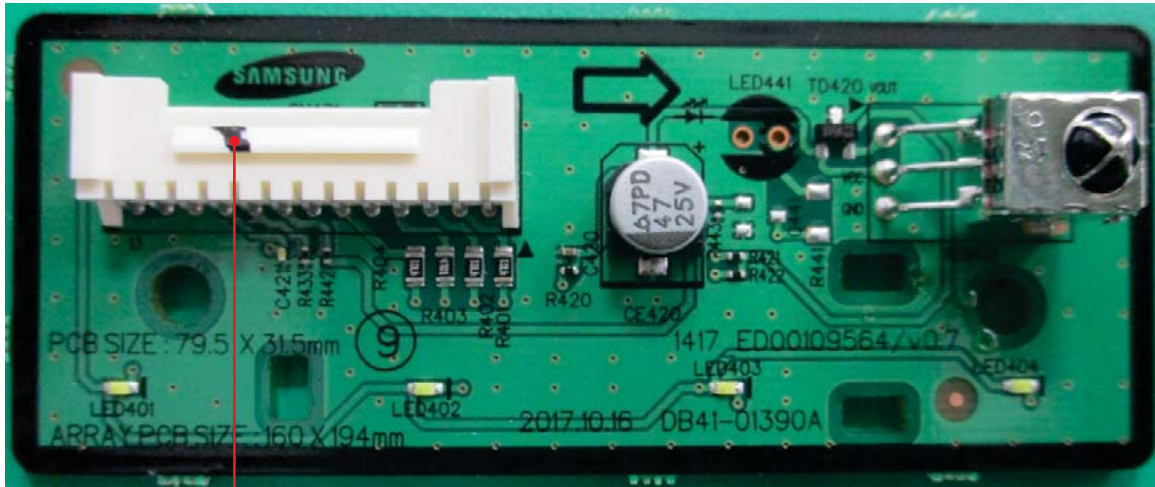

- |   |           |
|---|-----------|
| ① | CN808-EEV |
|---|-----------|
- #1: DC12V
  - #2: LED\_Operation
  - #3: LED\_Defrost
  - #4: LED\_Timer
  - #5: -
  - #6: LED\_Filter
  - #7: -
  - #8: Remocon Signal Out
  - #9: Panel Select
  - #10: Remocon Signal In
  - #11: GND
  - #12: DC5V
  - #13: -

## 5-2. Outdoor Unit

### ■ AJ020JCJ2CH/AJ024JCJ3CH

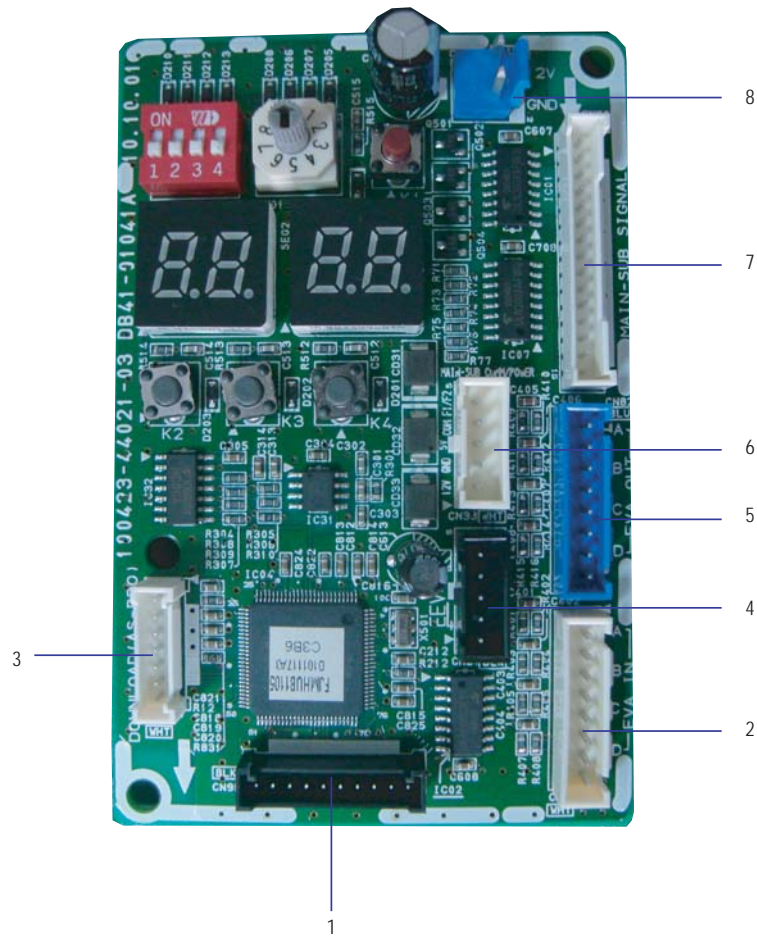

<b>1 CN95-MICOM DOWN</b> #1~#10 MICOM DOWN	<b>2 CN81 EVA IN SENSOR</b> #1~#2 EVA IN A #3~#4 EVA IN B #5~#6 EVA IN C #7~#8 EVA IN D	<b>3 CN10- AS PROM</b> #1~#7 MICOM DOWN (AS PRO USING)	<b>4 CN83-EEV D</b> #1~#4 EEV signal #5 DC 12V
<b>5 CN52 EVA OUT SENSOR</b> #1~#2 EVA OUT A #3~#4 EVA OUT B #5~#6 EVA OUT C #7~#8 EVA OUT D	<b>6 CN53 MAIN-HUB</b> #1 12V #2 GND #3 5V #4 COM1 #5 COM2	<b>7 CN80-Display</b> #1~#7 Segment 1~7 #8~#11 Key in #1~#4 #12~#15 Grid #1~#4	<b>8 CN12 - DC12V</b> #1 DC12V #2 GND



## ■ AJ036JCJ5CH MAIN PCB

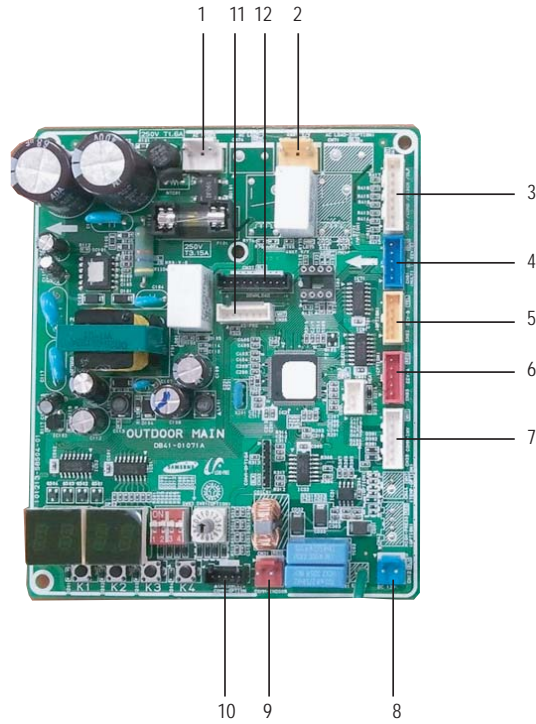

1 CN11-ACPOWER #1-#3 : 220-240 Vac	2 CN75-4WAY VV #1-#3 : 220-240 Vac	3 CN43-Sensor #1-#2 Outdoor Temp #3-#4 Cond Temp #5-#6 Discharge Temp #7-#8 OLP Temp	4 CN81-EEV C #1-#4 EEV signal #5 DC 12V
5 CN82-EEV B #1-#4 EEV signal #5 DC 12V	6 CN81-EEV A #1-#4 EEV signal #5 DC 12V	7 CN39-COMM-INV #1 TXD #2 RXD #3 GND #4 DC 5V #5 DC 12V #6 INV. SMPS signal	8 CN12 - DC12V #1 DC12V #2 GND
9 CN31 - COMM #1 : COM1 #2 : COM2	10 CN33-Sub Comm #1 DC12V #2 GND #3 DC5V #4 COM1 #5 COM2	11 CN37-MICOM DOWN #1-#10 MICOM DOWN	12 CN35- AS PROM #1-#7 MICOM DOWN (AS PRO USING)

## ■ AJ036JCJ5CH INVERTER PCB

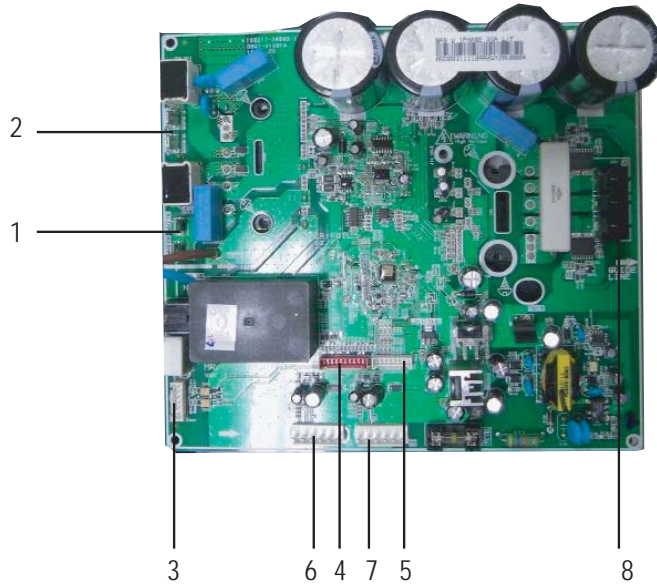

<p>① <b>Reactor-A1/B1</b> #Reactor-A2 : WHT #Reactor-B2 : WHT</p>	<p>② <b>Reactor-A2/B2</b> #Reactor-A2 : BLK #Reactor-B2 : BLK</p>	<p>③ <b>CN50(2PIN/RED)-Communication</b> #1 : RXD, #2 : TXD #3 : GND, #4 : DC 5V #5 : DC 12V, #6 : INV. SMPS signal</p>	<p>④ <b>CN22-Downloader</b> #1 : RXD_ATARO, #2 : TXD_ATARO #3, #8 : N.C, #4~#7 : DATA signal #9 : GND, #10 : DC 5V</p>
<p>⑤ <b>CN21-DAC/ENCODER</b> For S/W engineer debugging</p>	<p>⑥ <b>CN91-FAN2</b> #1 : DC 360V #2 : N.C #3 : GND #4 : DC 15V #5 : FAN RPM #6 : FAN RPM feedback</p>	<p>⑦ <b>CN90-FAN1</b> #1 : DC 360V #2 : N.C #3 : GND #4 : DC 15V #5 : FAN RPM #6 : FAN RPM feedback</p>	<p>⑧ <b>CN71-COMP.</b> #1 : COMP. U-phase(RED) #2 : COMP. V-phase(BLU) #3 : COMP. U-phase(YEL)</p>

## ■ AJ036JCJ5CH EMI PCB

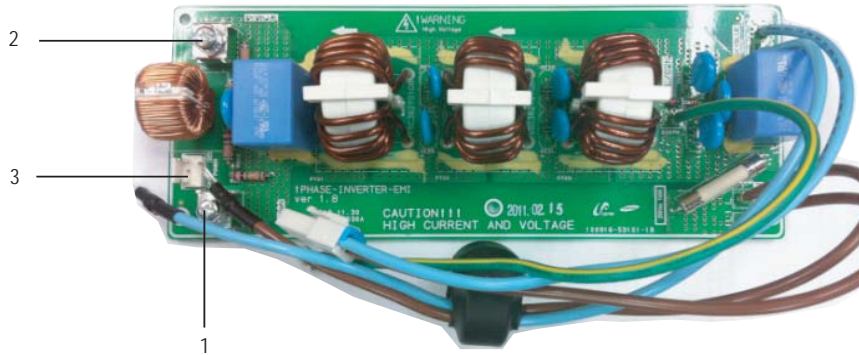

<b>① L1-AC POWER L phase</b> L1: BRN	<b>② N1-AC POWER N phase</b> N1: SKY-BLU	<b>③ CN01-AC POWER</b> #1-#3: AC 220~240V
---	---	--

## ■ AJ036JCJ5CH HUB PCB

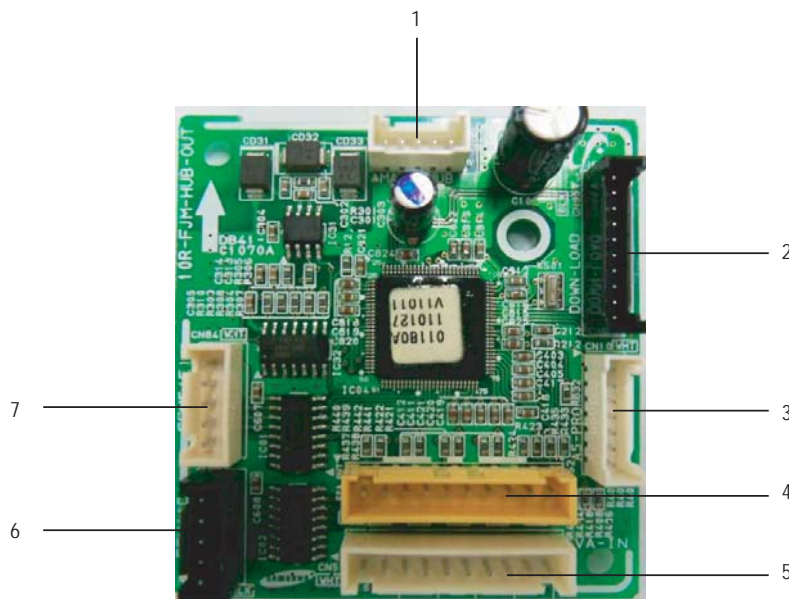

<b>1 CN33-Sub Comm</b> #1 DC12V #2 GND #3 DC5V #4 COM1 #5 COM2	<b>2 CN95-MICOM DOWN</b> #1-#10 MICOM DOWN	<b>3 CN10- AS PRO</b> #1-#7 MICOM DOWN (AS PRO USING)	<b>4 CN52 EVA OUT SENSOR</b> #1-#2 EVA OUT A #3-#4 EVA OUT B #5-#6 EVA OUT C #7-#8 EVA OUT D #9-#10 EVA OUT E
<b>5 CN51 EVA IN SENSOR</b> #1-#2 EVA IN A #3-#4 EVA IN B #5-#6 EVA IN C #7-#8 EVA IN D #9-#10 EVA IN E	<b>6 CN83-EEV D</b> #1-#4 EEV signal #5 DC 12V	<b>7 CN84-EEV E</b> #1-#4 EEV signal #5 DC 12V	

# 6. Wiring Diagram

## 6-1. INDOOR UNIT

### ■ AJ009JNNDCH/AJ012JNNDCH/AJ018JNNDCH

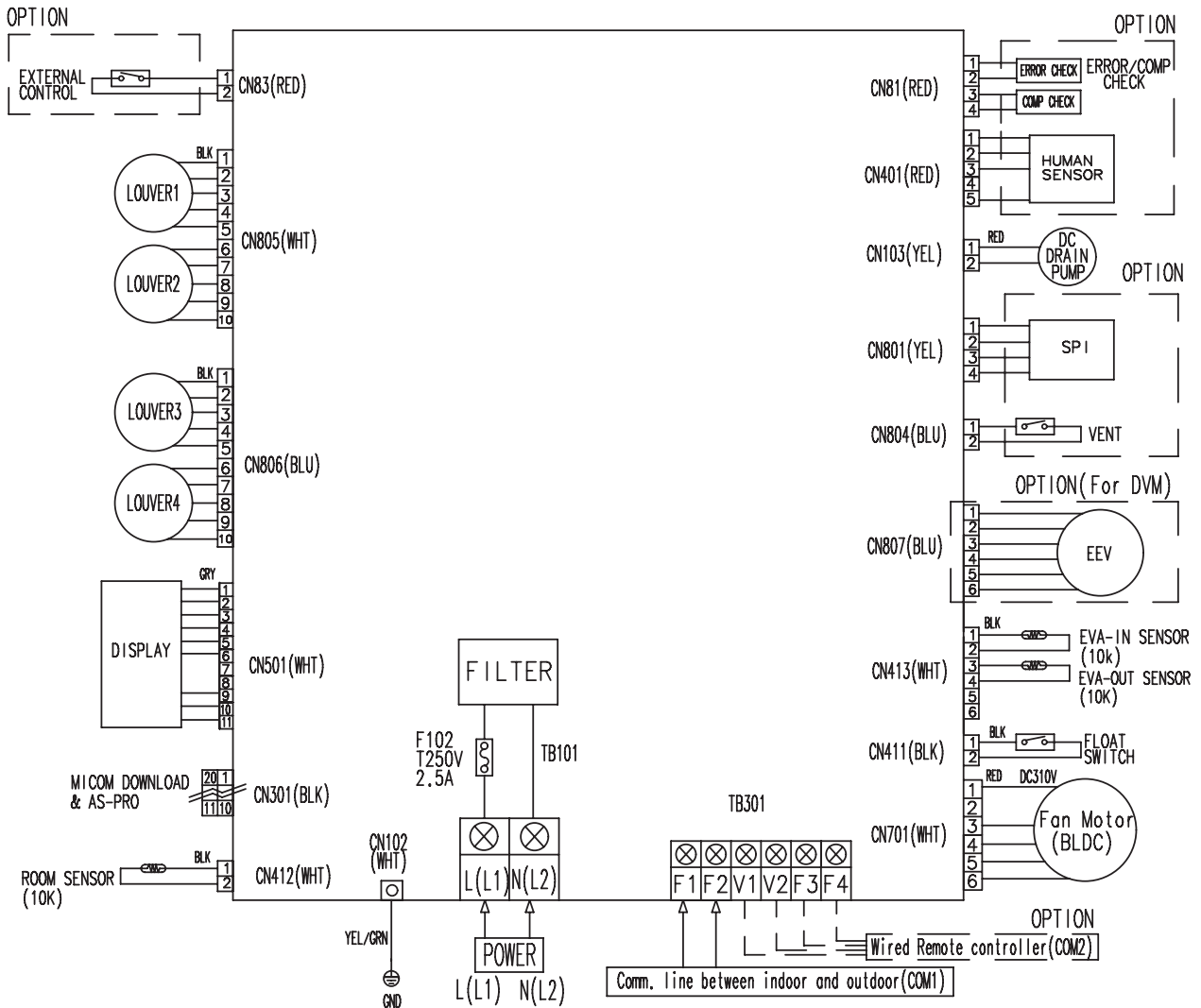

This Document can not be used without Samsung's authorization.

■ AJ007JNADCH/AJ009JNADCH/AJ012JNADCH/AJ018JNADCH/AJ024JNADCH

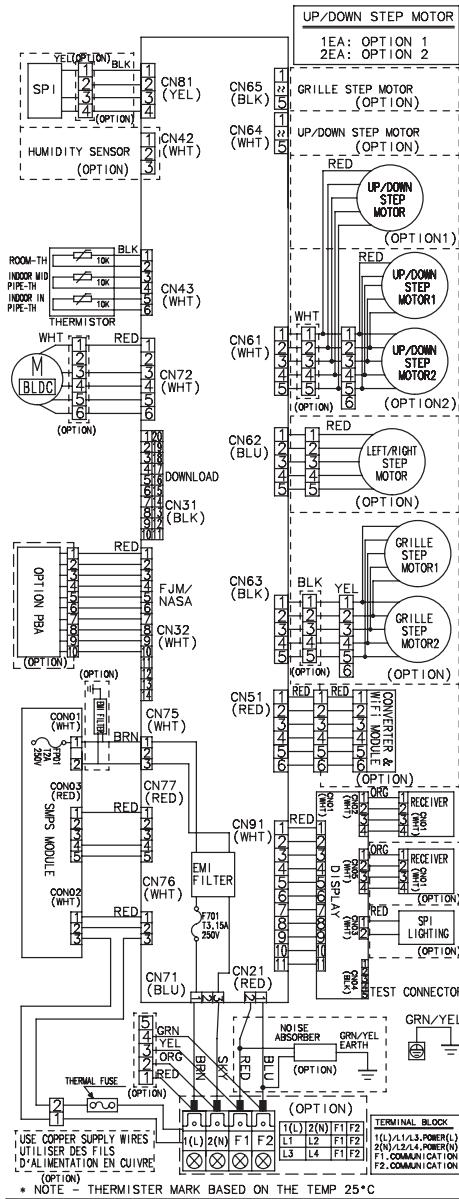

7-SEG	ERROR MODE			DESCRIPTION
	LED1 OPERATION	LED2 TIMER	LED3 OPTION	
E101,E102	○	●	●	Communication error (Indoor <-> outdoor)
E121	○	●	○	ROOM TH sensor error
E122,E123	●	●	○	INDOOR MID, INDOOR IN PIPE-TH sensor error
E154	○	○	●	Fan error(Indoor)
E162	●	●	●	EEPROM error
E163	●	●	○	Option error
FROM E200	○	○	○	Outdoor error display
E422	●	○	●	EEV or Valve Close error-Self diagnosis

● : LAMP ON    ○ : LAMP OFF    ● : LAMP BLINK  
 \* Note \*  
 If the Set doesn't work (No power), check the Thermal fuse of Terminal block OPEN or SHORT with Multimeter.  
 \* Measure the Thermal fuse housing PIN#1 ~ 2 :  
 OPEN(disconnection) -> defective product

This Document can not be used without Samsung's authorization.

■ AJ009JNLDCH/AJ012JNLDCH/AJ018JNLDCH

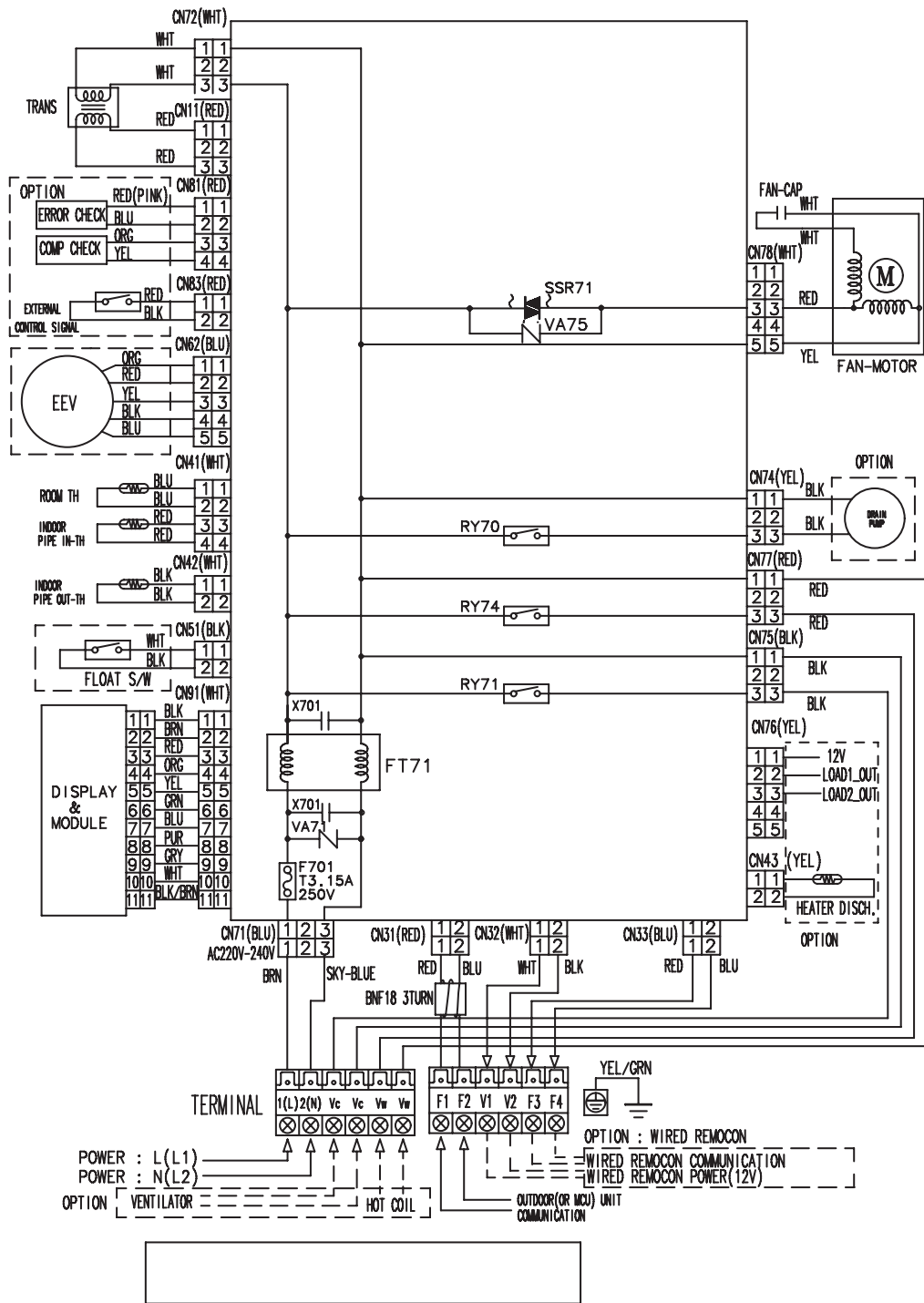

This Document can not be used without Samsung's authorization.

■ AJ\*\*\*NBNDCH/AA

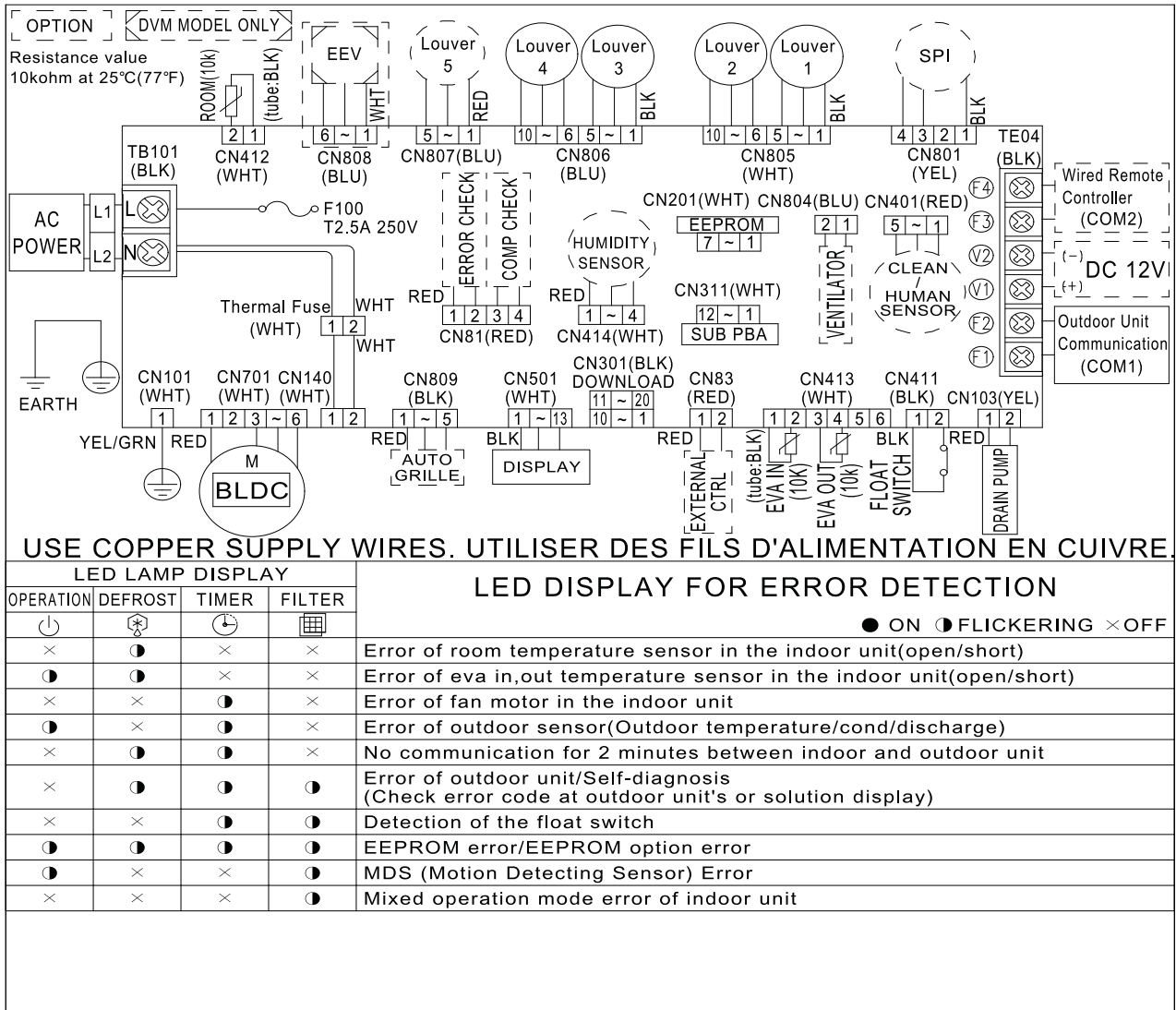

This Document can not be used without Samsung's authorization.

# 6-2. OUTDOOR UNIT

## ■ AJ020JCJ2CH/AJ024JCJ3CH

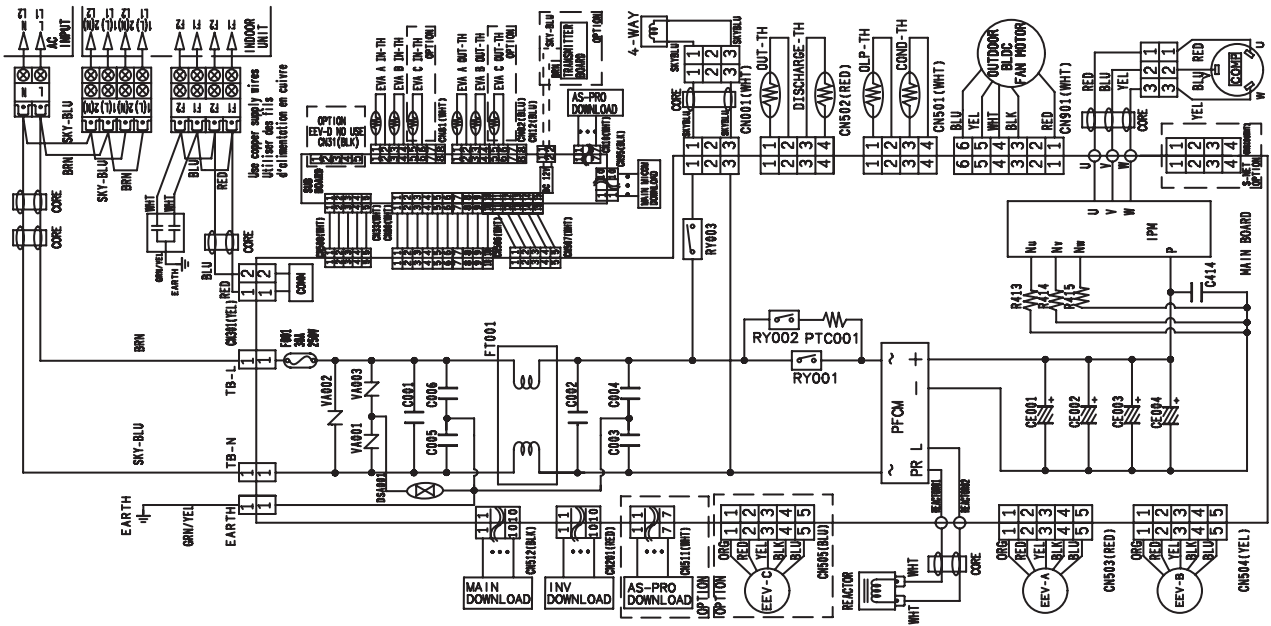



■ AJ036JCJ5CH

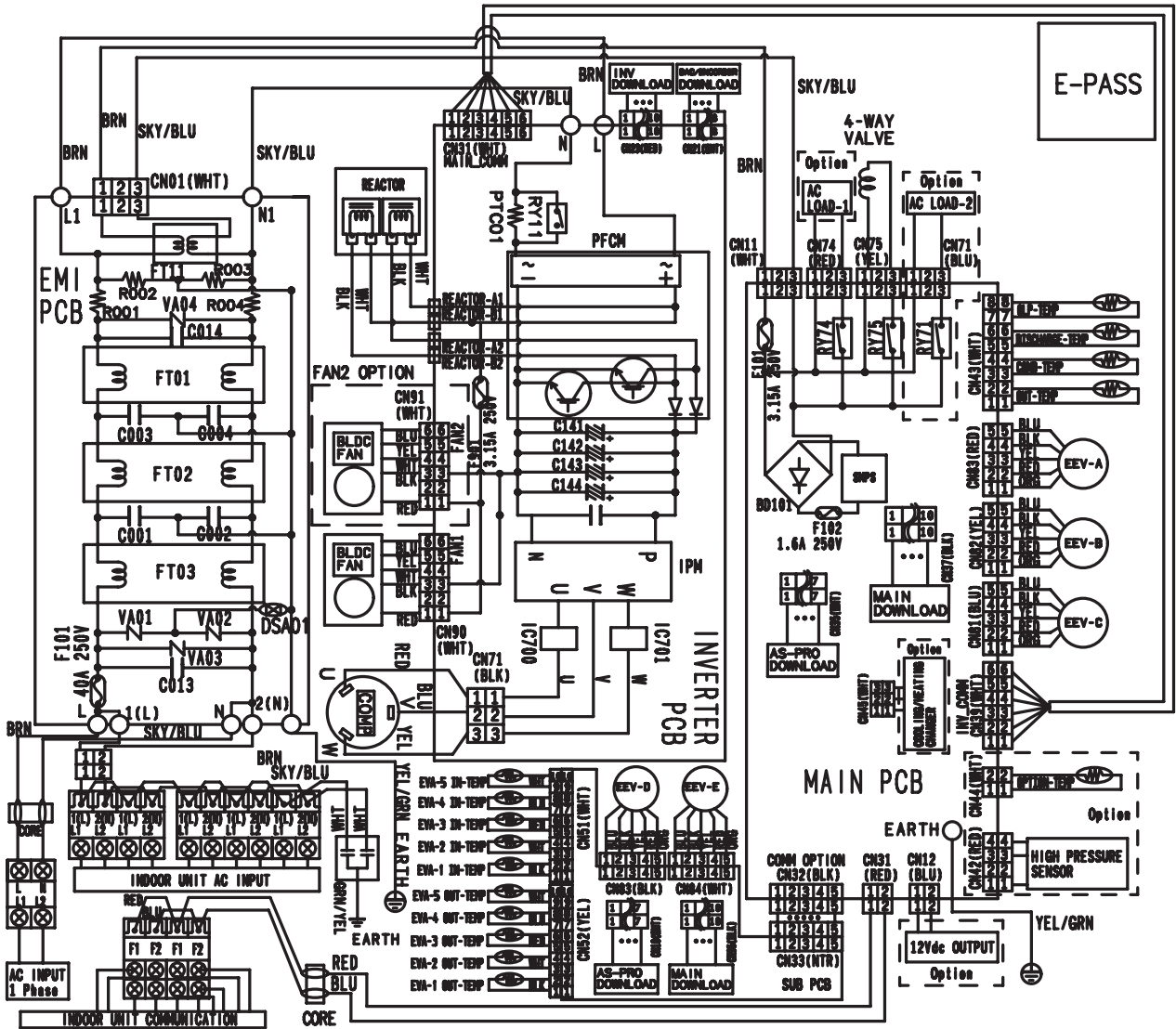

# MEMO

---

## 7. Reference Sheet

---

### 7-1 Selecting Area for Installaion

---

Select an area for installation that is suitable to customer's needs.

#### 7-1-1 Indoor Unit

- 1 Make sure that you install the indoor unit in an area providing good ventilation. It must not be blocked by an obstacle affecting the airflow near the air inlet and the air outlet.
- 2 Make sure that you install the indoor unit in an area allowing good air handling and endurance of vibration of the indoor unit.
- 3 Make sure that you install the indoor unit in an area where there is no source of heat or vapor nearby.
- 4 Make sure that you install the indoor unit in an area from which hot or cool air is spread evenly in a room.
- 5 Make sure that you install the indoor unit in an area away from TVs, audio units, cordless phones, fluorescent lighting fixtures and other electrical appliances (at least 1 meter).
- 6 Make sure that you install the indoor unit in an area which provides easy pipe connection with the outdoor unit, and easy drainage for condensed water.
- 7 Make sure that you install the indoor unit in an area which is large enough to accommodate the measurements shown in figure on the next page.



It is harmful to the air conditioner if it is used in the following environments: greasy areas (including areas near machines), salty areas such as coast areas, areas where sulfuric gas is present such as hot spring areas. Contact your dealer for advice.

### 7-1-2 Outdoor Unit

- 1 Make sure that you install the outdoor unit in area not exposed to the rain or direct sun light.(Install a separate sunblind if exposed to direct sun light.)
- 2 Make sure that you install the outdoor unit in area allowing the good air moment, not amplifying noise or vibration, especially to avoid disturbing neighbors. (Fix the unit firmly if it is mounted in a high place.)
- 3 Make sure that you install the outdoor unit in area providing the good ventilation and which is not dusty. It must not be blocked by any obstacle affecting the airflow near the air inlet and the air outlet.
- 4 Make sure that you install the outdoor unit in area free from animals or plants.
- 5 Make sure that you install the outdoor unit in area not blocking the traffic.
- 6 Make sure that you install the outdoor unit in area easy to drain condensed water from the indoor unit.
- 7 Make sure that you install the outdoor unit in area which provides easy connection within the maximum allowable length of a coolant pipe.  
If you install within 50m, no add a additional refrigerent : This model is chargeless within 50m.
- 8 Make sure that you install the outdoor unit in an area which is large enough to accommodate the measurements shown in figure on the next page.  
If you install the excessive length of pipe, add additional refrigerant as 20g or 10g per unit meter; refer to the table below.

Model	Total connecting pipe length (L)	Adding refrigerant
AJ020JCJ2CH	LT≤30m	Chargeless
	LT>30m	(LT- 30m)x10g
AJ024JCJ3CH	LT≤40m	Chargeless
	LT>40m	(LT- 40m)x10g
AJ036JCJ5CH	LT≤40m	Chargeless
	LT>40m	(LT- 40m)x20g

### 7-1-3 Remote Control Unit

- 1 Make sure that you use the remote control unit in an area free from obstacles such as curtains etc, which may block signals from the remote control unit.
- 2 Make sure that you put the remote control unit in an area not exposed to direct sunlight, and where there is no source of heat.
- 3 Make sure that you use the remote control unit in an area away from TVs, audio units, cordless phones, fluorescent lighting fixtures and other electrical appliances (at least 1 meter).

## 7-2 Connecting Up and Purging the Circuit



The air in the indoor unit and in the pipe must be purged. If air remains in the refrigeration pipes, it will affect the compressor, reduce to cooling capacity and could lead to a malfunction. Refrigerant for air purging is not charged in the outdoor unit. Use Vacuum Pump as shown at the right figure. Each unit must be purged in turn.

### ■ AJ020JCJ2CH/AJ024JCJ3CH/AJ036JCJ5CH

- 1 Check the piping connections.
- 2 Connect the charging hose of low pressure side of manifold gauge to the packed valve having a service port (5/8" Packed valve) as shown at the figure (Value stem: 1/2" - 20UNF).



WARNING

◆ Make the electrical connection and leave the system into "stand by mode". Do not turn on the system! This is necessary for better vacuum operation (full OPEN position of Electronic Expansion Valve - EEV -).

- 3 Open the valve of the low pressure side of manifold gauge counter clockwise.
- 4 Purge the air from the system using vacuum pump for about 30 minutes.
  - Close the valve of the low pressure side of manifold gauge clockwise.
  - Make sure that pressure gauge show  $-0.1\text{MPa}(-76\text{cmHg})$  after about 30 minutes.  
This procedure is very important in order to avoid gas leak.
  - Turn off the vacuum pump.
  - Remove the hose of the low pressure side of manifold gauge.
- 5 Set valve cork of both liquid side and gas side of packed valve to the open position.
- 6 Mount the valve stem nuts and the service port cap to the valve, and tighten them at the torque of  $183\text{kgf}\cdot\text{cm}$  with a torque wrench.
- 7 Check for gas leakage.
  - At this time, especially check for gas leakage from the 3-way valve's stem nuts, and from the service port cap.

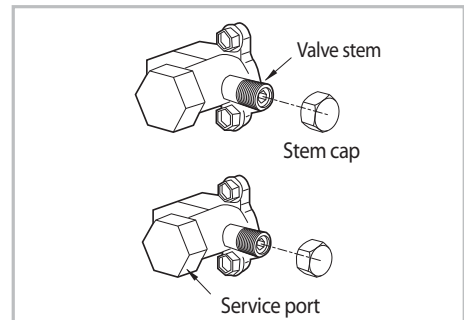
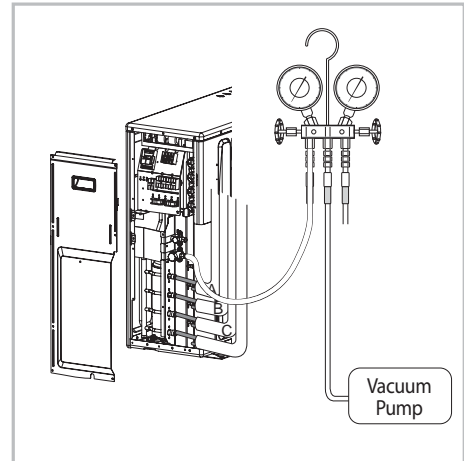

## 7-3 Refrigerant Refill

Refill an air conditioner with refrigerant when refrigerant has been leaked at installing or using.

1) Purge air(for new installation only).



2) Turn the 3 way valve clockwise to close, connect the pressure gauge (low pressure side) to the service valve, and open the 3 way valve again.



3) Connect the tank to refill with refrigerant.



4) Set the unit to cool operation mode.



5) Check the pressure indicated by the pressure gauge(low pressure side).

\* **Standard pressure should be 8.0-9.0kg/cm<sup>2</sup> in a regular and high operation mode.**



6) Open the refrigerant tank and fill with refrigerant until the rated pressure is reached.

\* **It is recommended not to pour the refrigerant in too quickly, but gradually while operating a pressure valve.**



7) Stop operation of the air conditioner.



8) Close the 3 way valve, disconnect the pressure gauge, and open the 3 way valve again.



9) Close the cap of each valve.

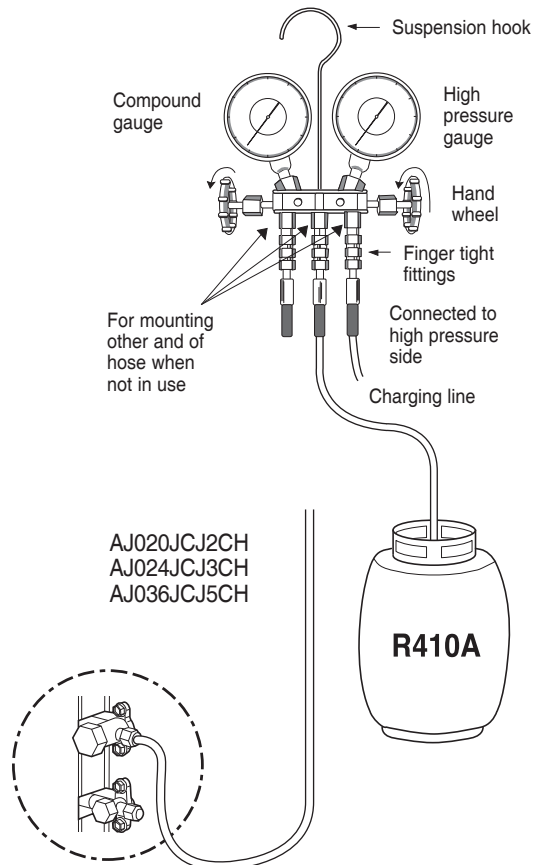

## 7-4 Refrigerant Adjustment

Class	At installation		At service	
	Air-Purge Method	Refrigerant Adjustment	Air-Purge Method	Refrigerant Quantity
Standard 30m (AJ020JCJ2CH)	Refer to the detailed connecting up and purging the circuit. (7-2 page)	Unnecessary	Purge air using a vacuum pump or an additional refrigerant cylinder.	refer to specification sheet
Standard 40m (AJ024JCJ3CH)				
Standard 40m (AJ036JCJ5CH)				
Standard<Total≤50m (AJ020JCJ2CH)		In case of exceeding total pipe length 30m, Add "10g" of refrigerant (R410A) for every 1m		In case of exceeding total pipe length 30m, Add "10g" of refrigerant (R410A) for every 1m
Standard<Total≤70m (AJ024JCJ3CH)		In case of exceeding total pipe length 40m, Add "10g" of refrigerant (R410A) for every 1m		In case of exceeding total pipe length 40m, Add "10g" of refrigerant (R410A) for every 1m
Standard<Total≤80m (AJ036JCJ5CH)	In case of exceeding total pipe length 40m, Add "20g" of refrigerant (R410A) for every 1m	In case of exceeding total pipe length 40m, Add "20g" of refrigerant (R410A) for every 1m		

It would be the best choice to use the standard tube length to keep the basic quality of Room Air conditioner, for example cooling capacity, sound level, vibration level, and reliability.

But, according to a certain different installation condition, the connection tube length could be changed in the recommendation length that is shown above.

In this case, installer should keep the installation condition to keep the quality of Room Air conditioner.

- Refrigerant should be charged additionally as written above according to the change of the length of the connection tube.

It needs to affect the decrease in cooling and heating capacity or of the reliability of compressor that may be caused by a lack of refrigerant.

- Installation position difference between the indoor unit and the outdoor unit should not exceed over than 15 meters.

- When the connection pipe is been extended longer than 5 meters, it might need to change the diameter of the electrical wire to a larger size in order to keep a voltage drop for starting room air conditioner is not less than 85% of the rated voltage. And then, a voltage meter will be useful to check the rate of the voltage drop.

## 7-5 Flare Nut Fixing Torque

Outer Diameter (D)	Thickness	Torque	
		N·m	ft·lb(kgf·cm)
ø6.35 mm(1/4")	0.8 mm(0.03 ")	14~18	10.1~13.0(140~180)
ø9.52 mm(3/8")	0.8 mm(0.03 ")	34~42	25.3~31.1(350~430)
ø12.70 mm(1/2")	0.8 mm(0.03 ")	49~61	36.2~44.8(500~620)
ø15.88 mm(5/8")	0.8 mm(0.03 ")	68~82	49.9~60.0(690~830)

## 7-6 "Pump down" Procedure

Pump down will be carried out when an evaporator is replaced or when the unit is relocated in another area.

AJ020JCJ2CH/AJ024JCJ3CH/AJ036JCJ5CH

1) Remove the caps from the 3/8" service valve and the 5/8" service valve.



2) Turn the 5/8" service valve clockwise to close and connect a pressure gauge (low pressure side) to the service valve, and open the 5/8" service valve again.



3) Set the unit to cool operation mode.  
(Check if the compressor is operating.)



4) Turn the 3/8" service valve clockwise to close.



5) When the pressure gauge indicates "0" turn the 5/8" service valve clockwise to close.



6) Stop operation of the air conditioner.



7) Close the cap of each valve.

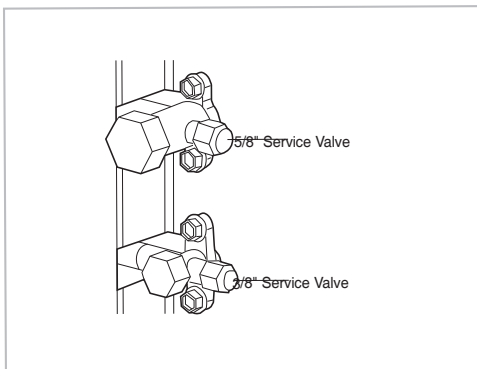

### Remarks

#### Relocation of the air conditioner

- Refer to this procedure when the unit is relocated.
  1. Carry out the pump down procedure (refer to the details of 'pump down').
  2. Remove the power cord.
  3. Disconnect the assembly cable from the indoor and outdoor units.
  4. Remove the flare nut connecting the indoor unit and the pipe.  
At this time, cover the pipe of the indoor unit and the other pipe using a cap or vinyl plug to avoid foreign material entering.
  5. Disconnect the pipe connected to the outdoor unit.  
At this time, cover the valve of the outdoor unit and the other pipe using a cap or vinyl plug to avoid foreign material entering.
  6. Make sure you do not bend the connection pipes in the middle and store together with the cables.
  7. Move the indoor and outdoor units to a new location.
  8. Remove the mounting plate for the indoor unit and move it to a new location.



# 7-7 Index of Model Name

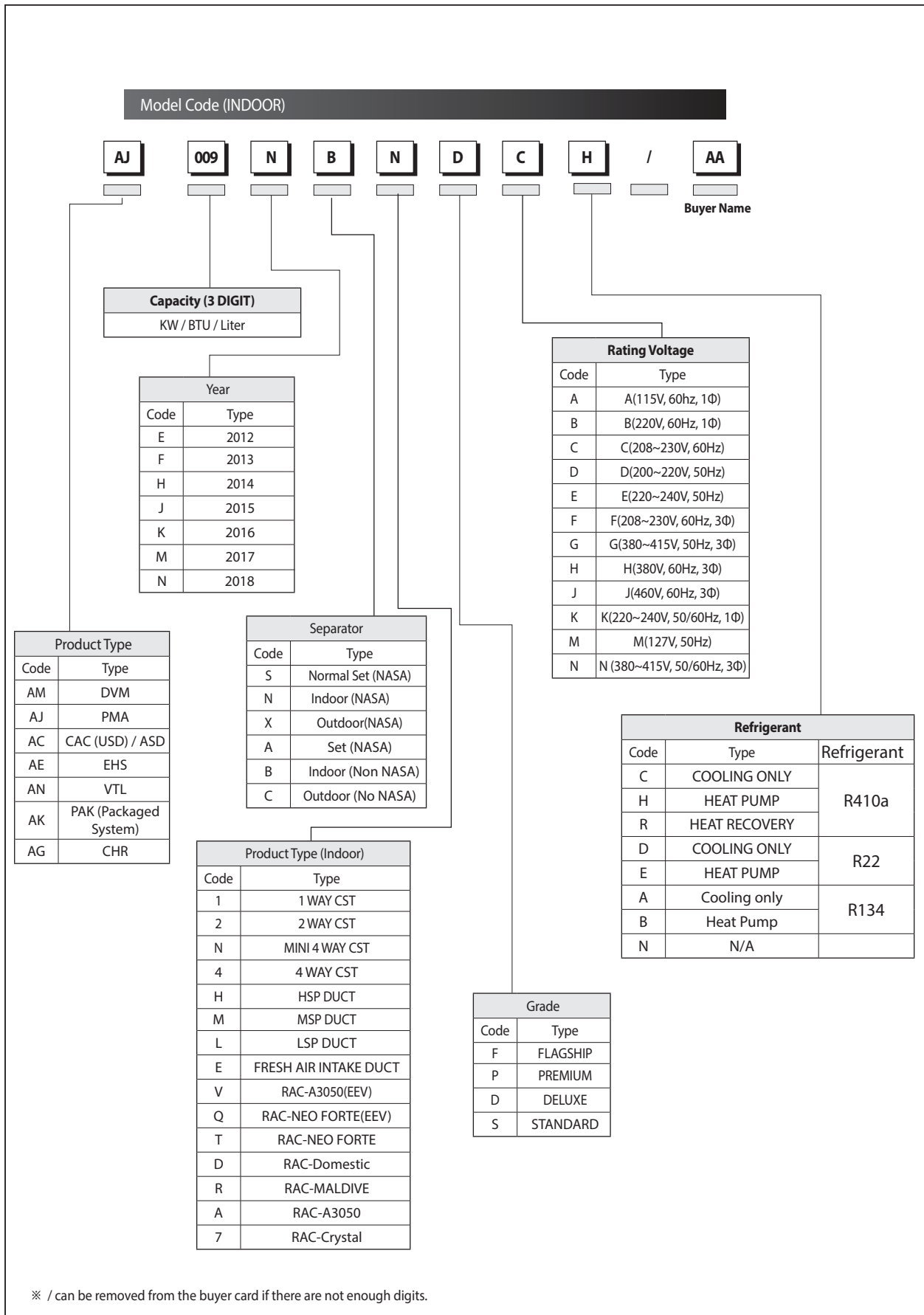

Model Code (OUTDOOR)

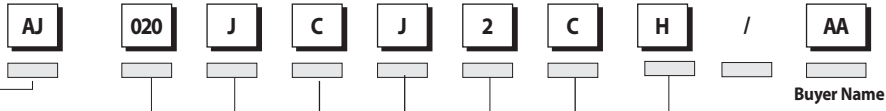

Capacity	
BTU/H(*100)	
CMH(*10)	
HP(/10)	
WATT(*100)	

Year	
Code	Type
E	2012
F	2013
H	2014
J	2015
K	2016
L	2017

Rating Voltage	
Code	Type
A	A(115V, 60hz, 1Φ)
B	B(220V, 60Hz, 1Φ)
C	C(208~230V, 60Hz)
D	D(200~220V, 50Hz)
E	E(220~240V, 50Hz)
F	F(208~230V, 60Hz, 3Φ)
G	G(380~415V, 50Hz, 3Φ)
H	H(380V, 60Hz, 3Φ)
J	J(460V, 60Hz, 3Φ)
K	K(220~240V, 50/60Hz, 1Φ)
M	M(127V, 50Hz)
N	N (380~415V, 50/60Hz, 3Φ)

Product Type	
Code	Type
AM	DVM
AJ	PMA
AC	CAC (USD) / ASD
AE	EHS
AN	VTL
AK	PAK
AG	CHR

Separator	
Code	Type
S	Normal Set (NASA)
N	Indoor (No NASA)
X	Outdoor(NASA)
A	Set (NASA)
B	Indoor (NASA)
C	Outdoor (No NASA)

Refrigerant		
Code	Type	Refrigerant
C	COOLING ONLY	R410a
H	HEAT PUMP	
R	HEAT RECOVERY	R22
D	COOLING ONLY	
E	HEAT PUMP	R134
A	Cooling only	
B	Heat Pump	
N	N/A	

Feature	
Code	Type
J	IFREE JOINT MULTI
P	PACK MULTI
H	DVM HOME

Grade	
Code	Type
2	2 Room
3	3 Room
4	4 Room
5	5 Room
N	Multi Room

\* PMA is FJM Model.

※ / can be removed from the buyer card if there are not enough digits.

## 7-8 Refrigerating Cycle Diagram

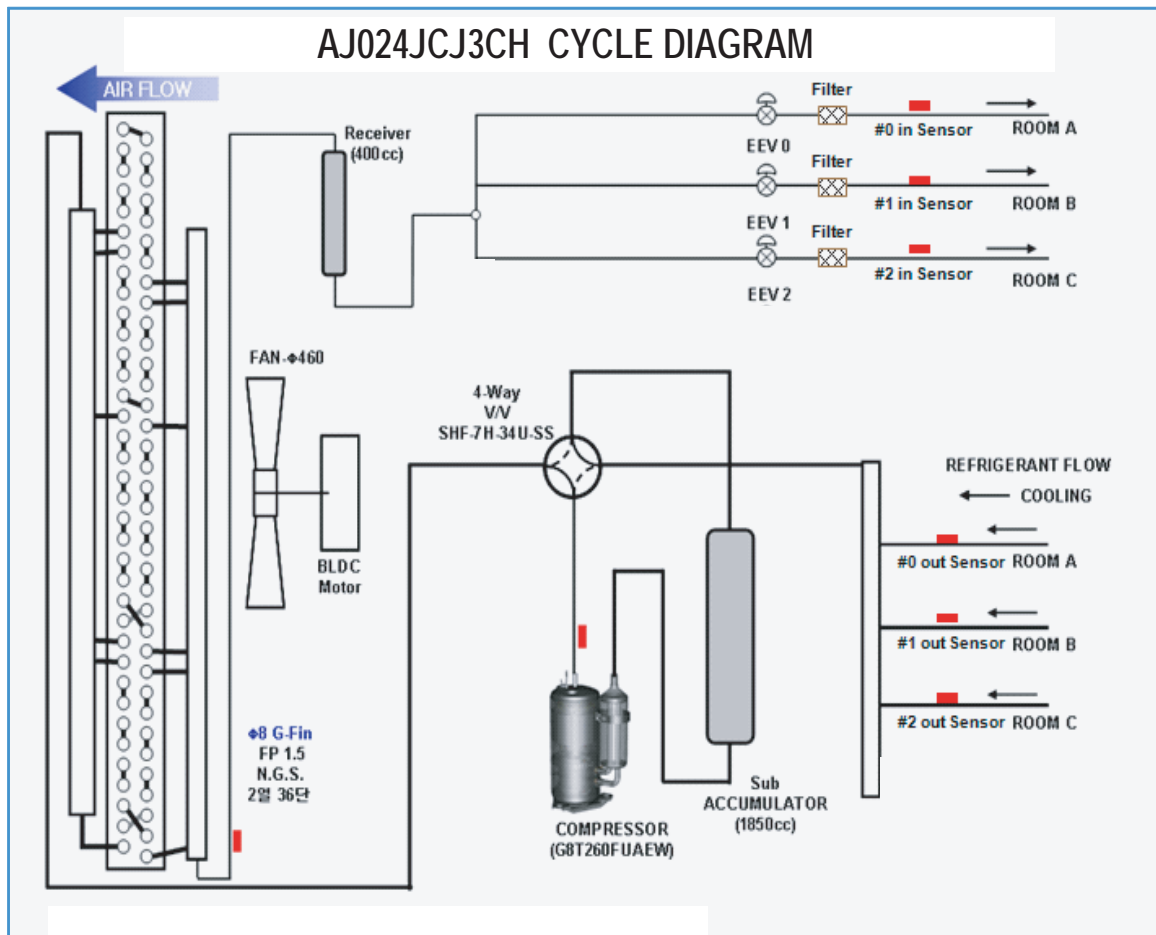
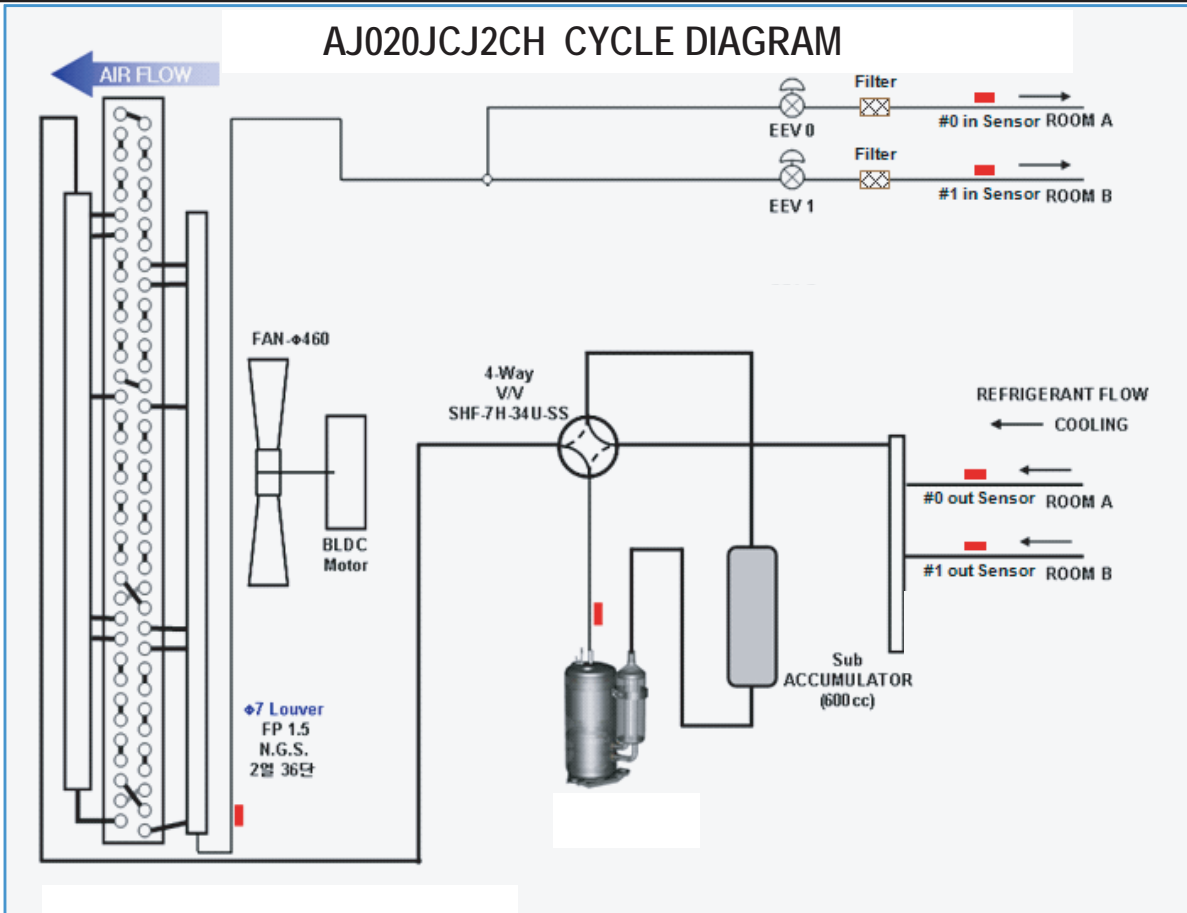

# AJ036JCJ5CH CYCLE DIAGRAM

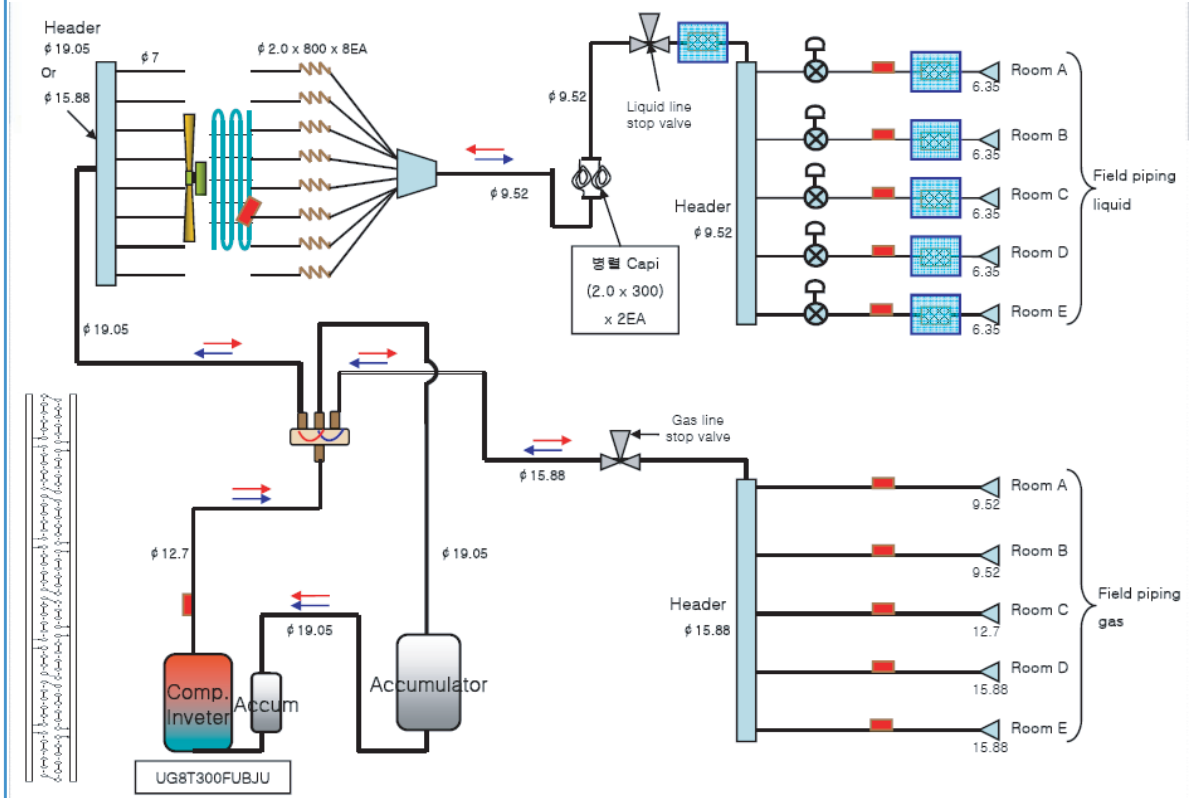

## 7-9 Pressure & Capacity mark

### ■ Power/Heat

W	cal/s	kcal/h	Btu/h	HP	kg·m/s	ib·m/s
1	0.23885	0.85985	3.4121	0.001341	0.10197	0.73756
4.1868	1	3.6	14.286	0.0056146	0.42693	3.088
1.163	0.27778	1	3.9683	0.0015596	0.11859	0.85778
0.29307	0.06999	0.252	1	3.9302x10 <sup>-4</sup>	0.029885	0.21616
745.7	178.11	641.19	<b>2,544.4</b>	1	76.04	550
9.8067	2.3423	8.4322	33.462	0.013151	1	7.233
1.3558	0.32383	1.1658	4.6262	0.0018182	0.13826	1

## 7-10 The abbreviated technology words & the definition of technology terms

Abbreviated technology words	Definition of technology terms
COMP(Full name compressor)	One that compresses, especially a machine used to compress gases.
BLOWER	One that blows, especially a mechanical device, such as f fan, that produces a current of air.
FAN	A device for reeating a current of air or a breeze.
ASS'Y CONTROL BOX (Full name : Assemble control box)	A restraining device of air-condition, measure, or limit.
MOTOR	Something, such as a machine or an engine, that produces or imparts motion.
ASS'Y EVAP/ASS'Y COND (Full name : assemble evaporator / assemble condenser)	Heat exchanger; A device, used to transfer heat from a fluid on one side of a barrier to a fluid on the other side without bringing the fluids into direct contact.

## 7-11 Q & A for Non-trouble

Classification	Class	Description
Cooling	Q	<b>The cooling is weak.</b>
	A	When it is hot outside, its cooling capacity decreases due to the increase of the ambient temperature. When the dust filter gets blocked or warm outside air gets in, the cooling capacity will decrease. So, make sure to clean the dust filter frequently, prevent heat loss by closing the doors and insulate the cooling area by using curtains, blinds, shades or window tinting.
	Q	<b>The cooling is good generally. But, it gets weak when it is considerably hot.</b>
	A	It occurs when the outdoor unit is exposed to direct sun light and heat-up air is not ventilated well. So, set up a sunblind over the outdoor unit and keep stuff away from the unit to increase the ventilation. When the cooling capacity decreases during a heat wave, clean the heat exchanger of the outdoor unit or spray some cold water to the heat exchanger to increase the cooling capability.
	Q	<b>The cooling is weak. Does it need refrigerant charging?</b>
	A	It is not correct charging refrigerant regularly. Except that you have moved in several times or the connection pipes are broken, the refrigerant does not run low. So, when refrigerant is additionally charged, it could be costly and cause a product's failure. When the refrigerant leaks, all of it will escape in a short time resulting in cooling failure and no water coming out of the drain hose. So, if water comes out from the drain hose, it indicates the normal operation of the product and it does not need refrigerant charging.
	Q	<b>It fails to do cooling.</b>
	A	When the air conditioner is set to Ventilation or the desired temperature is set higher than the current temperature, it fails to do cooling. In this case, select Cooling or set the desired temperature lower.
Leakage	Q	<b>It floods the floor.</b>
	A	Place the drain hose properly. When it is not placed properly, the drain water would flow back flooding the floor. So, straighten out the drain hose for the water to be drained well.
	Q	<b>Water drips at the drain connection (service valve) of the outdoor unit.</b>
	A	When a glass bottle is taken out of the refrigerator, moisture gets condensed on its surface due to the temperature differences. The same principle applies to the air conditioner. When cold refrigerant goes through the copper tube, moisture gets condensed on the surface of the tube and the connection areas. To prevent the water condensation, the pipes are insulated. But, the connection areas of the outdoor unit are not insulated for the purpose of maintenance or repair, and water gets condensed due to the temperature differences and drips down. Generally, it evaporates right away. But, when it drips much during muggy days, put a water pan on the floor.
	Q	<b>It leaks even though a drain pump is used.</b>
A	It occurs when the drain pump is plugged out or it is out of order. Check the power of the drain pump and the position of the drain hose, and when the pump is faulty, contact the drain pump manufacturer. Samsung Electronics do not manufacture drain pumps. So, we are not able to correct the drain pump problems.	
Smells	Q	<b>Whenever the air conditioner is turned on, it irritates my eyes and gives me a headache.</b>
	A	There are no components in the air conditioner irritating the eyes and sending out chemical smells. But, when the air conditioner is turned on, other smell sources are sucked into the air conditioner and get out of it. So, find and root out the smell sources. Generally, it occurs at a interior renovated place, a pharmacy, a gasoline handling place, a tire shop, a second-hand book shop or an electronic

## Q & A for Non-trouble (cont.)

Classification	Class	Description
Smells		component handling place; when its chemical or musty smells are sucked in and sent out, it can be misled that the air conditioner generates them. So, find and root out the problem or refresh the room frequently.
	Q	<b>Whenever the air conditioner is turned on, it stinks.</b>
	A	There are no components in the air conditioner sending out chemical smells. But, when the air conditioner is turned on, other smell sources are sucked into the air conditioner and get out of it. So, find and root out the smell sources. Generally, when the drain hose is taken out to the washing room or there are sources of smells such as a diaper bin, a shoe shelf or a socks bin, bad smells generate. Also, it occurs where glass cleaners or air fresheners are used; when they are sucked in interacting with dusts and moistures inside, bad smells generate. These kinds of organic materials noxious to human bodies. So, we recommend against the use of them.
	Q	<b>Whenever the air conditioner is turned on, it smells sour.</b>
	A	When the room is papered recently, its paste smells would be sucked inside. Also, when the air conditioner is installed in the study room of young boys loving sweat-generating activities such as the basketball, excessive sweats evaporate and get sucked into the air conditioner resulting in bad smells. So, find and root out the problem or refresh the room frequently.
	Q	<b>Whenever the air conditioner is turned on, it smells musty.</b>
	A	It is due to the improper keeping of the product after its use. When keeping the product, dry up the inside with the operation of Ventilation to prevent must. When the product is kept without drying up the inside with Ventilation, mold would grow inside resulting in must. So, open the windows and switch on the Ventilation function to get rid of the saturated smell inside.
	Q	<b>Whenever the air conditioner is turned on, it sends out bad smells such as stale smells.</b>
	A	It occurs generally when there are pet animals in the house. Their smells stay at the same place. But, when the air conditioner is turned on, the air gets circulated resulting in the circulation of the smells. So, find and root out the problem or refresh the room frequently.
	Q	<b>It sends out bad smells.</b>
A	When the air filter is filthy, it could send out bad smells. So, clean the filter and ventilate the room with the windows open while operating the Ventilation function.	
Operation	Q	<b>It won't start.</b>
	A	There is a power failure or it is plugged out. Also, check if the power distribution panel is switched off.
	Q	<b>It goes off during operation.</b>
	A	When the hot air does not escape properly, it goes off during operation. It occurs when it does not ventilate properly because the outdoor unit is covered, the back of the outdoor unit is blocked by a cardboard or a plywood panel, and the front of the outdoor unit is blocked by the closed window or other obstacles. Clear the above obstacles from the outdoor unit.
	Q	<b>It generally works properly. But, when it's considerably hot, it goes off during operation.</b>
	A	It occurs when the outdoor unit is exposed to direct sunlight and the hot air does not escape properly. Set up a sun blind over the outdoor unit and clear the neighboring obstacles from the outdoor unit to provide good ventilation. When it goes off frequently during a heat wave, it would prevent the turn-off and increase the cooling capacity cleaning the outdoor unit or spraying some water to the heat exchanger.

## Q & A for Non-trouble (cont.)

Classification	Class	Description
Operation	Q	<b>The remote controller won't operate.</b>
	A	When the batteries run out or the transmitter or receiver of the remote controller is blocked by obstacles, change the batteries or keep the obstacles away from the controlling area. Also, the remote controller may not work under intensive light from a 3-wave length lamp or a neon sign due to the EMI. In this case, take the remote controller closer to the receiver.
Installation	Q	<b>Who installs the air conditioner? (Relocation/Re-installation)</b>
	A	When relocating or re-installing the air conditioner, make sure to contact Samsung Electronics Service Center or Authorized Service Agent and have them to do the job.(If not, it could cause personal injury or product damage.) The cost for the relocation/re-installation of the air conditioner is subject to the customer's expense. There is a cost table. But, our service engineer needs to visit to total up the cost correctly. When you move in, make sure to contact Samsung Electronics Service Center or Authorized Service Agent in advance to streamline the process.
	Q	<b>Is it possible to install the outdoor unit outside?</b>
	A	It is possible to install it at a designated place in the apartment or on the rooftop nearby. But, it's illegal hanging an angle iron case with the outdoor unit in it outside the apartment. Also, it is illegal obstructing passers-by with the outdoor unit installed outside.
	Q	<b>What can be done to install the outdoor unit facing the road because it is a commercial building?</b>
	A	The following is an excerpt from Building Code going into effect from JUNE 1st 2005. "The exhaust pipe of a cooling or ventilation facility installed in a building adjacent to the streets of commercial or residential areas shall be installed higher than 2m to prevent the exhaust air from blowing directly to passers-by and the current facilities shall be corrected by MAY 31st 2005." So, please install it higher than 2m or not to blow the hot exhausting air directly to passers-by.
	Q	<b>What about installing a windscreen during installation not to blow hot air directly to passers-by?</b>
A	When the hot air from the front of the outdoor unit is blocked, the product's performance will be affected and it will fail to operate properly. So, keep it at least 300mm away from its surrounding walls and give it good ventilation.	



## 7-12 Common sense of refrigeration

---

### ■ Air supplier?

It supplies fresh air to the building or room through procedure of air circulation for fresh environment.

### ■ Effectiveness of air supplier

It diminishes the stress or fatigue and enhances vivid desire through fresh air circulation. Also, filthy air indoor is being cleaned by Air-Filter and it keeps clean and fresh environment and dehumidification. Temperature, humidity, air stream, cleanness are called for factors of air supplier and they are kept in proper condition for usage purpose.

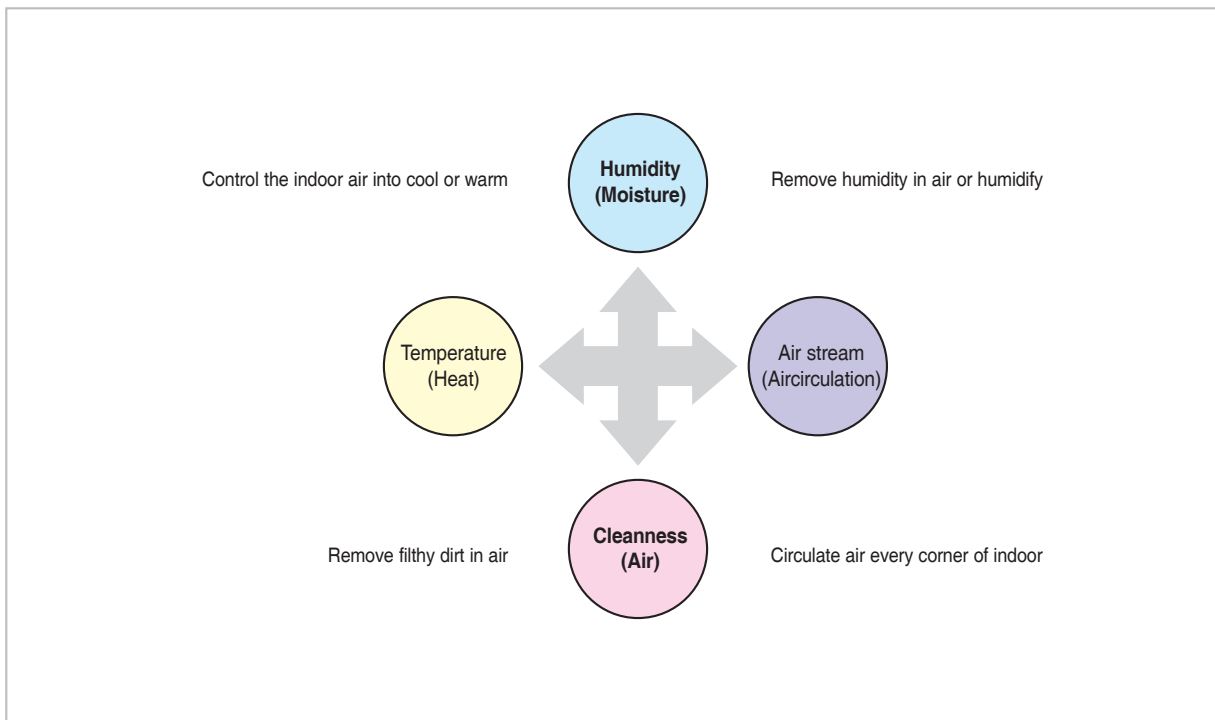

### ■ Four factors of air suppliers

The human body keeps regular temperature regarding the human body's freshness.

For keeping freshness, heat generated from human body should emit outside of the body by air circulation, conduction, emission, and evaporation. The human body feels freshness when the emission rate is 40~45%, which was emitted by a radiation when it is comfortable and warm, and air circulation and conduction is 20~30%, and evaporation is 20~24%.

It sometimes may depends on seasonal factor, wearing condition, age, sex and mental state other than indoor environment. But generally the value of fresh indoor temperature is that below 0.2(m/s) of indoor air circulation, the temperature is 21~28°C when the wall temperature is the same as the indoor's and relative humidity is 30~31% in summer, the winter temperature is 20~24°C and relative humidity is 30~60% in winter.



This Service Manual is a property of Samsung Electronics Co., Ltd.  
Any unauthorized use of Manual can be punished under applicable  
International and/or domestic law.

© Samsung Electronics Co., Ltd. 2018.  
Printed in China.

---